



VXRF10-28 SERIES

HIGH RELIABILITY COTS EMI FILTERS



Product Overview

Output: 10 A
Operation: -55 °C to 105 °C

1.0 DESCRIPTION

The VXR Series of EMI filters is the latest and most advanced offering in VPT's extensive line of high reliability COTS products. Building on a proven design heritage, the VXRF10 features low resistance, high attenuation and a wide input voltage range. When paired with a VXR Series DC-DC Converter, the VXRF10 passes specific DO-160 and MIL-STD-461 conducted EMI requirements. The VXR product family is optimized for a broad range of applications from military ground vehicles to commercial and military aircraft.

The VXR Series patent-pending epoxy-encapsulated V-SHIELD™ packaging is highly resistant to chemical, solvent and salt environments and is fully compatible with high volume manufacturing processes including wave solder, cleaning solvents, high pressure sprays and aqueous wash processes. A unique integral six-sided metalized shield improves system EMI compatibility. Dual sided conduction cooling coupled with reduced power dissipation simplifies system thermal design.

The VXR series is intended for harsh environments including severe vibration, shock and temperature cycling. Testing is to JESD22, MIL-STD-810, and MIL-STD-883.

1.1 FEATURES

- Up to 10 A maximum current
- Up to 200 W output power
- Wide input voltage range: 0 V to 60 V
- High Input Voltage transient: 80 V for 1 second, 100 V for 200 milliseconds
- 55 dB minimum attenuation at 500 kHz
- Rugged epoxy encapsulated V-SHIELD™ Package
- Fully compatible with aqueous cleaning processes
- Integral six-sided metalized EMI shield
- Dual-Sided Thermal Conduction
- 2000 V Isolation

1.2 COMPLIANCE

- MIL-STD-1275 A-D – Including starting disturbances
- RTCA / DO-160 Section 16
- MIL-STD-704 A-F
- MIL-STD-461 C-G when used with appropriate VXR DC-DC Converter
- RTCA / DO-160-section 18 and 21 when used with appropriate VXR DC-DC Converter

1.3 PACKAGING

- Low-profile: 1.700" x 1.300" x 0.380"
- Max weight: 38 g

1.4 SIMILAR PRODUCTS AND ACCESSORIES

- [VPTF10](#) 10 Amp metal package COTS EMI Filter
- [VXR30](#) 30 W single output encapsulated COTS DC-DC Converter
- [VXR100](#) 100 W single output encapsulated COTS DC-DC Converter
- [VPT100](#) 100 W single output metal package COTS DC-DC Converter
- [DVMD](#) 7 Amp Military Qualified EMI Filter
- [EMI filters, Thermal Pads, Front-End Modules and Accessories](#)

2.0 DESCRIPTION

2.1 BLOCK DIAGRAM

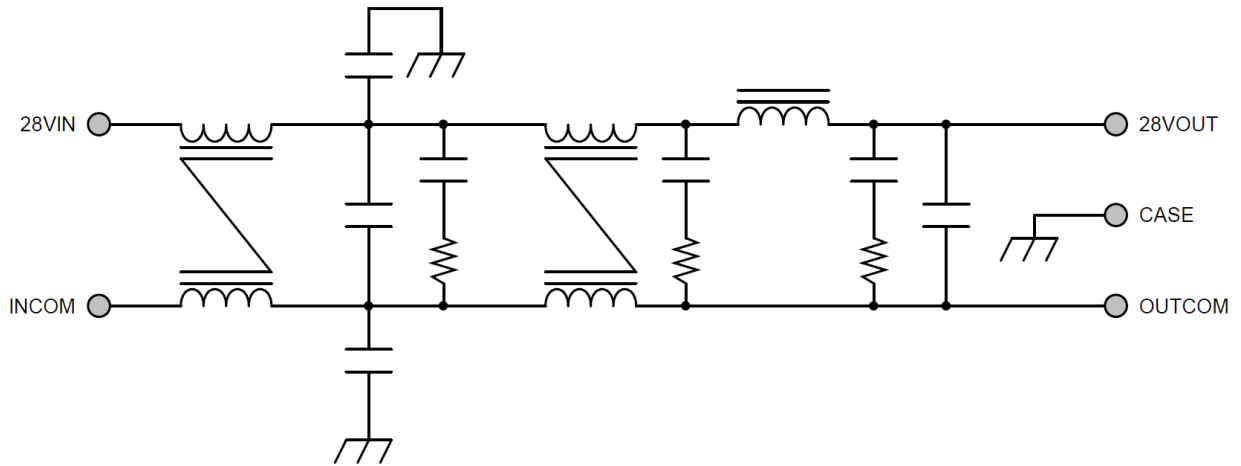

2.2 CONNECTION DIAGRAM

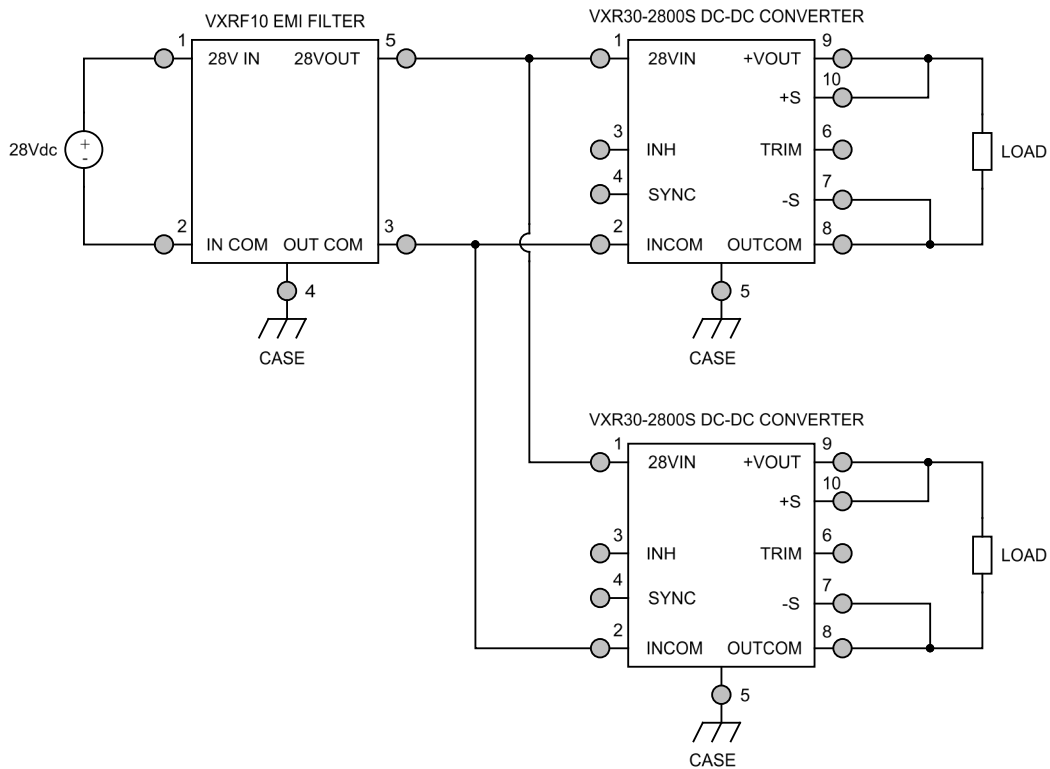



3.0 SPECIFICATIONS

3.1 ABSOLUTE MAXIMUM RATINGS

Absolute Maximum Ratings			
Input Voltage (Continuous):	60 V	Operating Temperature (Full Load):	-55 °C to + 105 °C
Input Voltage (Transient, 1 second):	80 V	Storage Temperature:	-55 °C to + 125 °C
Input Voltage (Transient, 200 ms):	100 V	Lead Solder Temperature (10 seconds):	300 °C

3.2 PERFORMANCE SPECIFICATIONS

Tcase = -55 °C to +105 °C, Vin = +28 V ± 5%, Full Load, Unless Otherwise Specified

Parameter	Conditions	VXRF10-28			Units
		Min	Typ	Max	
INPUT					
Voltage	Continuous	0	28	60	V
	Transient ² , 1 sec	-	-	80	V
	Transient ² , 200 ms	-	-	100	V
OUTPUT STATIC					
Voltage		Vout = Vin – (lin x RDC)			V
Current ¹		0	-	10	A
Power		0	-	200	W
GENERAL					
DC Resistance		-	65	120	mΩ
Power Dissipation ²		-	-	12	W
Noise Rejection	f = 500 kHz	55	67	-	dB
Capacitance	Any pin to case	20	-	33	nF
Isolation	Any pin to case, 2000 VDC	100	-	-	MΩ
Weight	Standard package option	-	-	38	g
MTBF (MIL-HDBK-217F)	GM @ Tcase= 55 °C	-	2.39	-	MHr

1. Derate linearly to 0 at 115 °C.

2. Verified by initial electrical design verification. Post design verification, parameter shall be guaranteed to the limits specified.

4.0 PERFORMANCE CURVES

4.1.1 VXR100-2800S without EMI Filter

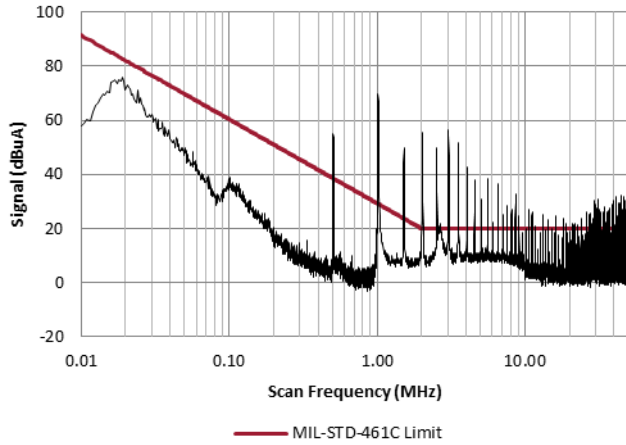

4.1.2 VXR100-2800S with EMI Filter

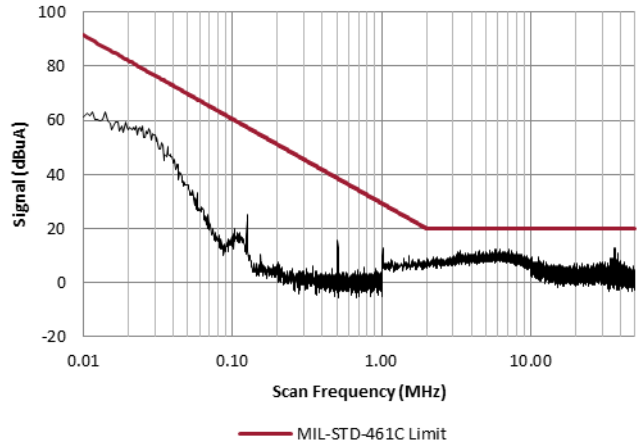

4.1.3 VXR100-2800S without EMI Filter

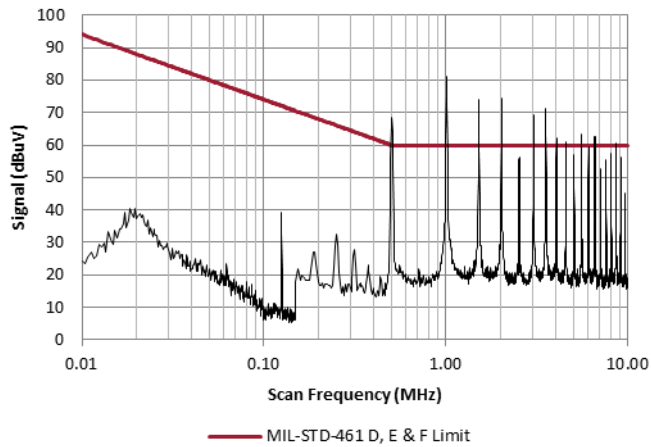

4.1.4 VXR100-2800S with EMI Filter

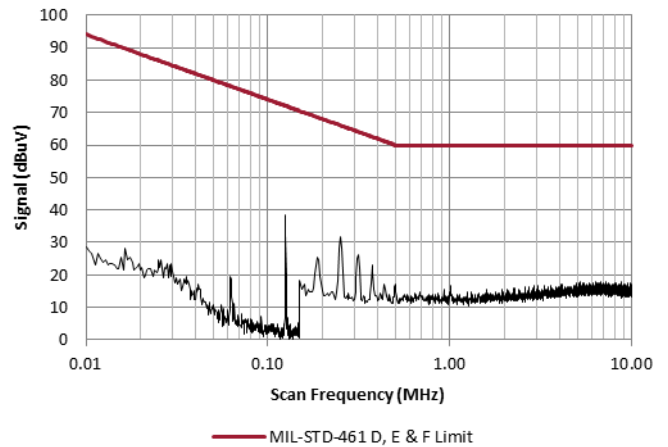

4.1.5 VXR100-2800S without EMI Filter

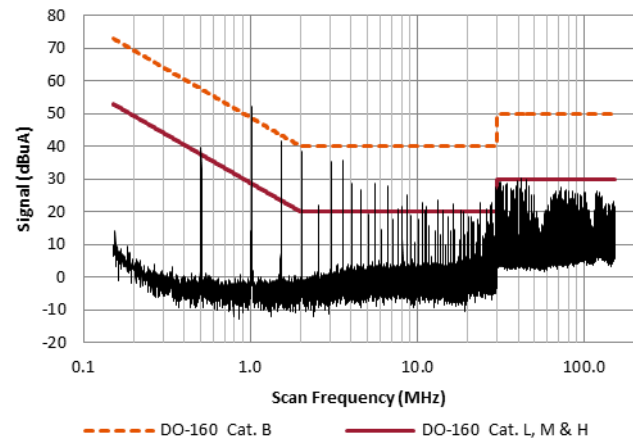

4.1.6 VXR100-2800S with EMI Filter

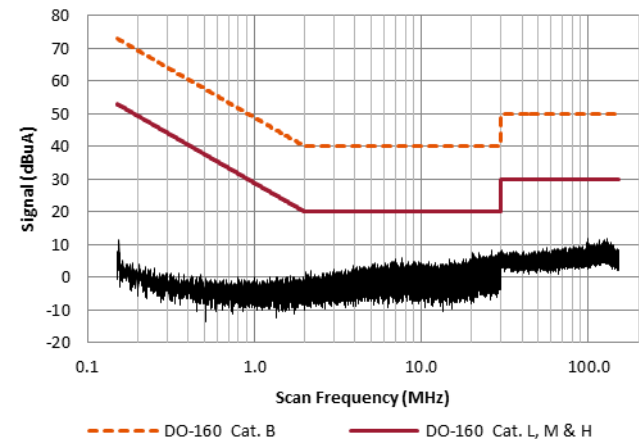

5.0 MECHANICAL OUTLINES AND PINOUT

Standard Package:

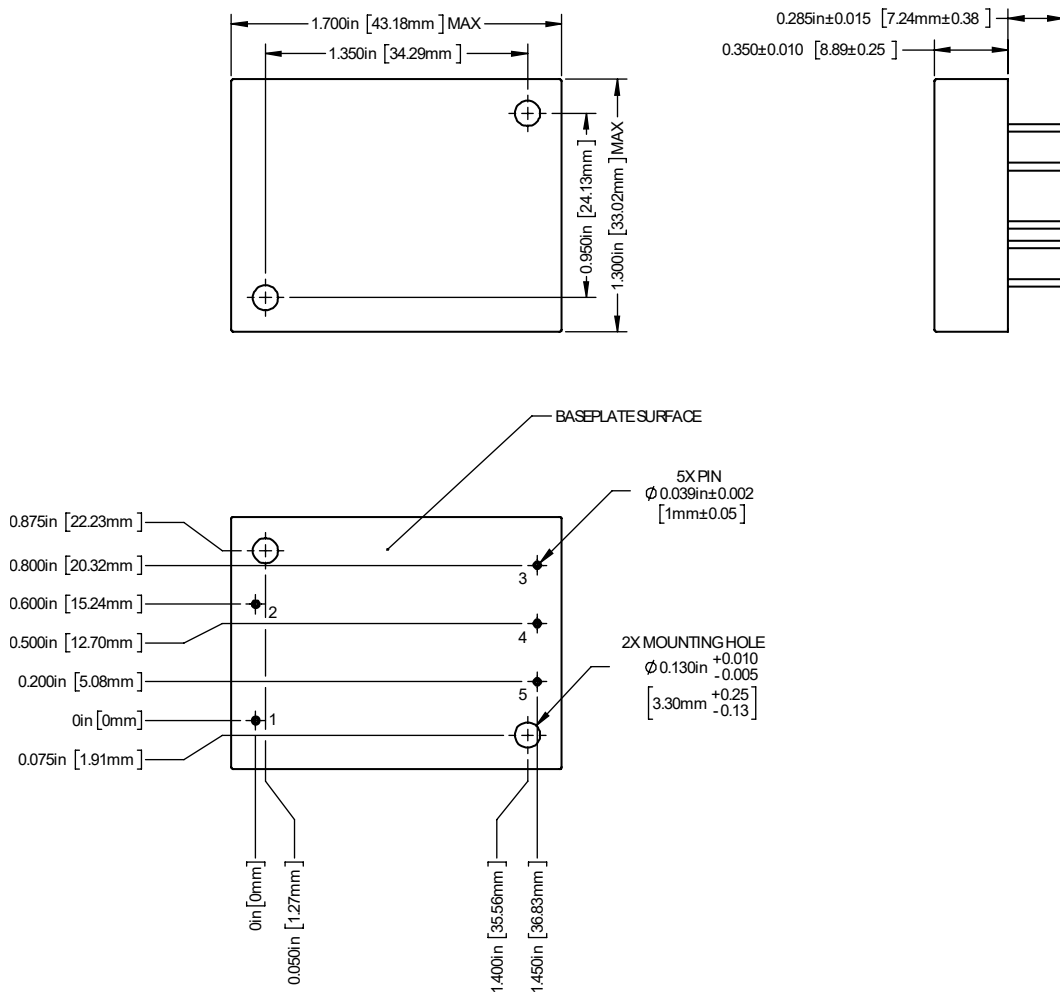

1. Tolerances are ±0.005" unless otherwise stated
2. Case temperature is measured on the center of the baseplate surface
3. Mounting holes are not threaded. Recommended fastener is 4-40
4. Materials: Body (Epoxy with integral metalized EMI shield); Pin (Tellurium Copper, alloy 145, gold over nickel plating)

Pin	Function	Pin	Function
1	28VIN	4	CASE
2	INCOM	5	28VOUT
3	OUTCOM		



6.0 COMPLIANCE

When used with compatible VXR or VPT series converters.

Specification	Compliance
MIL-STD-461 C-F	CE03
	CE102
	CS101
MIL-STD-704 A-F	Input voltage
	Distortion spectrum
	Voltage spikes ¹
MIL-STD-1275 A-D	Input voltage, including starting disturbances
	Ripple ²
	Voltage spikes ³
DO-160 E-G, Section 16	Steady state voltage
	Ripple voltage
	Abnormal surge voltage
DO-160 E-G, Section 18	Categories B, R, K and Z ⁴
DO-160 E-G, Section 21	Conducted RF emissions

1. Source impedance is 50 Ohms
2. Injected current limited to 1 Arms per SAEJ1113-2
3. Energy limited to 15 mJ or less
4. Baseplate temperature limited to Table 4-1 Operating high temperature

7.0 ENVIRONMENTAL SCREENING

Test	Condition
Internal Visual	IPC-A-610, Class 3
Temperature Cycling	MIL-STD-883, Method 1010, Condition B, -55 °C to +125 °C, 10 Cycles
Burn In	96 hours at +105 °C
Final Electrical	100% at 25 °C
External Visual	Internal Procedure



8.0 ORDERING INFORMATION

VXRF10-	28
1	2

(1) Product Series	(2) Nominal Input Voltage
VXRF10-	28 28 Volts

Please contact your sales representative or the VPT Inc. Sales Department for more information concerning additional environmental screening and testing, different input voltage, output voltage, power requirements, and source inspection.

9.0 CONTACT INFORMATION

To request a quotation or place orders please contact your sales representative or the VPT, Inc. Sales Department at:

Phone: (425) 353-3010
Fax: (425) 353-4030
E-mail: vptsales@vptpower.com

All information contained in this datasheet is believed to be accurate, however, no responsibility is assumed for possible errors or omissions. The products or specifications contained herein are subject to change without notice. VPT, its logo and tagline are registered trademarks in the U.S. Patent and Trademark Office.

10.0 ADDITIONAL INFORMATION

Visit the VPT website for additional technical resources, including:

[Product Catalogs](#)



[Technical Video Labs](#)



[Application Notes and White Papers](#)



Additional Products For [Avionics/Military](#), [Hi-Rel COTS](#), and [Space Applications](#)

