

### DESCRIPTION

The VPTPCM-12 is a Pre-Conditioning Module which allows VPT's DV and VPT series isolated DC-DC converters to operate over an extended input voltage range and provides compliance to both MIL-STD-704 and MIL-STD-1275 input power requirements. A wide input voltage range accommodates both nominal 12V and 28V inputs including avionics, mobile, ground systems, and other applications. A high efficiency design reduces input power requirements and eases thermal management. Low input and output ripple, fixed operating frequency, and companion EMI filters simplify system design and compliance. A proven design heritage, no optoisolators and a rugged all metal or optional epoxy encapsulated package ensure long term reliability.

The VPTPCM-12 intended for harsh environments including severe vibration, shock and temperature cycling. Testing is to JESD22, MIL-STD-810, and MIL-STD-883.

These converters are designed and manufactured in a facility certified to ISO9001, J-STD-001 and IPC-A-610.

This product may incorporate one or more of the following U.S. patents:

5,784,266  
5,790,389  
5,963,438  
5,999,433  
6,005,780  
6,084,792  
6,118,673

### FEATURES

- High Reliability at Low Cost
- Up to 120 Watts of Output Power
- Wide Input Voltage Range: 9 to 40 Volts per MIL-STD-704 and MIL-STD-1275
- Transient Operation down to 6 Volts and up to 100 Volts per MIL-STD-1275
- High Efficiency, Up to 99%
- Inrush Current Limiting
- Input Undervoltage Lockout
- Fixed Frequency
- Output Soft Start
- Wide Temperature Range, -55°C to 100°C
- Internally Conformal Coated
- Standard Six Sided Non-Hermetic Rugged Metal Package
- Optional Six Sided Rugged Epoxy Encapsulated Package with Integral Metalized EMI shield that is fully compatible with aqueous cleaning processes



**Figure 1** – VPTPCM-12 Preconditioning Module Standard Metal Package



**Figure 2** – VPTPCM-12W Preconditioning Module Optional Epoxy Encapsulated Package

(Not to Scale)



# VPTPCM-12 Series

## SPECIFICATIONS (T<sub>CASE</sub> = -55°C to +100°C, V<sub>IN</sub> = +28V ± 5%, Full Load, Unless Otherwise Specified)

### ABSOLUTE MAXIMUM RATINGS

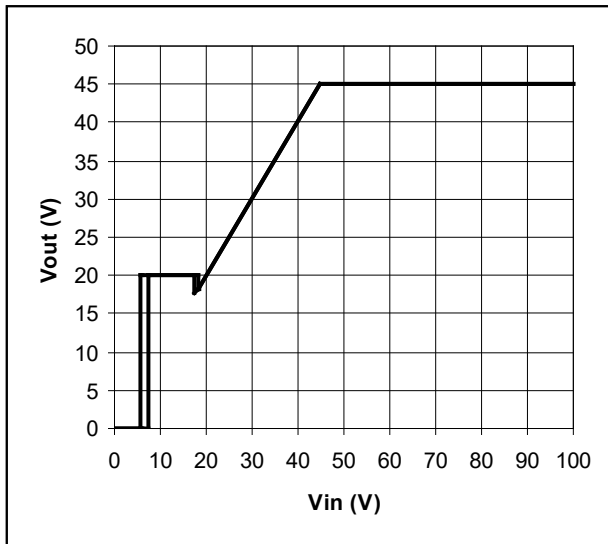
Input Voltage (Continuous)	40 V <sub>DC</sub>	Junction Temperature Rise to Case	+15°C
Input Voltage (Transient, 50 ms)	100 Volts	Storage Temperature	-55°C to +125°C
Output Power	120 Watts	Lead Solder Temperature (10 seconds)	300°C
Power Dissipation (Full Load, T <sub>CASE</sub> = +100°C)	17 Watts	Weight (Maximum)	79 Grams

Parameter	Conditions	VPTPCM-12			Units	
		Min	Typ	Max		
<b>STATIC</b>						
INPUT Voltage	Continuous	9	-	40	V	
	Transient <sup>3</sup>	10 sec	8	-	V	
	Transient <sup>1,3</sup>	1 sec, Pout = 100W maximum	6	-	V	
	Transient	1 sec	-	50	V	
	Transient	50 ms, 500 mΩ	-	-	100	V
	Transient	70 μs, 15 mJ	-250	-	250	V
	Transient	10 μs, 50Ω	-	-	600	V
Current	Inhibited	-	-	25	mA	
	V <sub>in</sub> = 12V, No Load	-	-	300	mA	
	V <sub>in</sub> = 28V, No Load	-	-	35	mA	
Inrush Current <sup>3</sup>	V <sub>in</sub> = 0 to 28V, Full Load	-	3	5	A	
Ripple Current	V <sub>in</sub> = 12V, Full Load, 20Hz to 10MHz	-	-	250	mA <sub>p-p</sub>	
Inhibit Pin Input <sup>3</sup>		0	-	1.5	V	
Inhibit Pin Open Circuit Voltage		14	16	18	V	
UVLO Turn On		6.5	-	7.9	V	
UVLO Turn Off <sup>3</sup>		4.5	-	5.9	V	
OUTPUT Voltage	Continuous	17	-	40	V	
	Transient	-	-	50	V	
Power <sup>2</sup>		0	-	120	W	
Ripple Voltage	V <sub>in</sub> = 12V, 20Hz to 10MHz	-	-	500	mV <sub>p-p</sub>	
EFFICIENCY	V <sub>in</sub> = 28V	97	99	-	%	
	V <sub>in</sub> = 12V	88	92	-	%	
CAPACITIVE LOAD <sup>3</sup>		-	-	500	μF	
SWITCHING FREQUENCY		400	500	550	kHz	
CASE ISOLATION	500 V <sub>DC</sub>	100	-	-	MΩ	
MTBF (MIL-HDBK-217F)	GM @ T <sub>c</sub> = 55°C	-	400	-	kHrs	
<b>DYNAMIC</b>						
Turn On Delay	V <sub>IN</sub> = 0V to 28V	-	2	6	mSec	
	V <sub>IN</sub> = 0V to 12V	-	10	25	mSec	

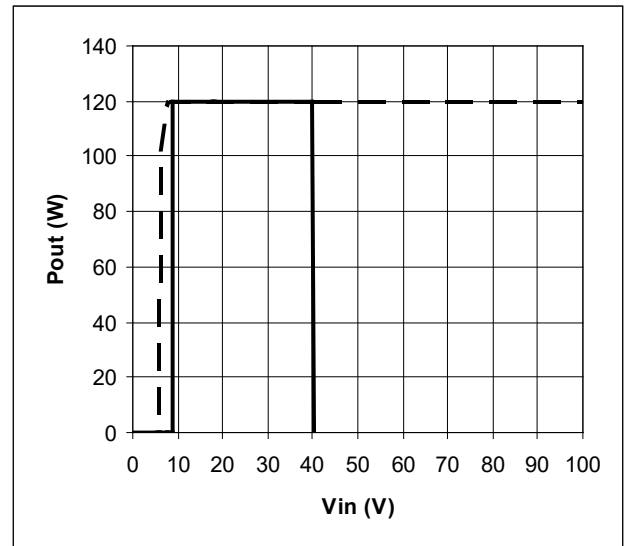
- Notes:
1. Operation down to 6V is possible after the input voltage is taken above 8V to start the module
  2. Derate linearly to 0 at 110°C
  3. Verified by qualification testing



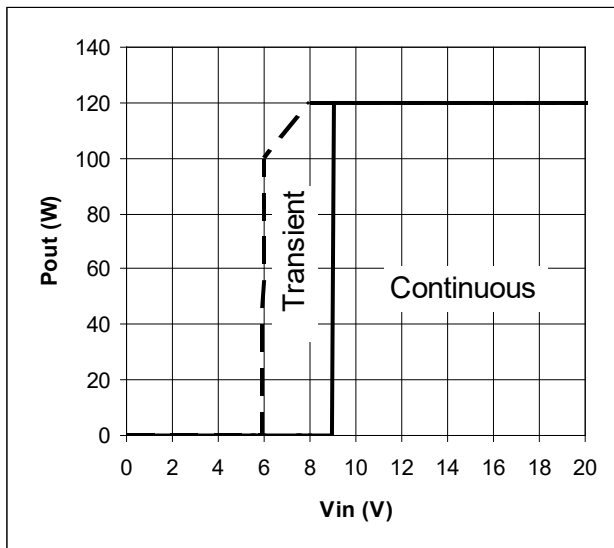
## PERFORMANCE CURVES



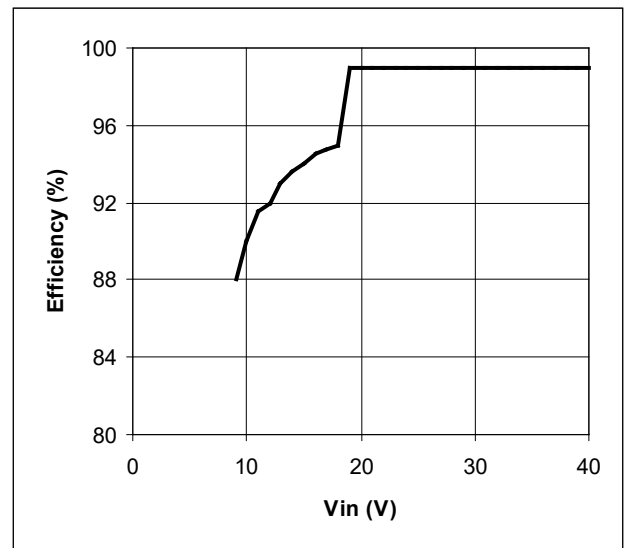
**Figure 5** – Output Voltage vs Input Voltage



**Figure 6** – Output Power Rating vs Input Voltage

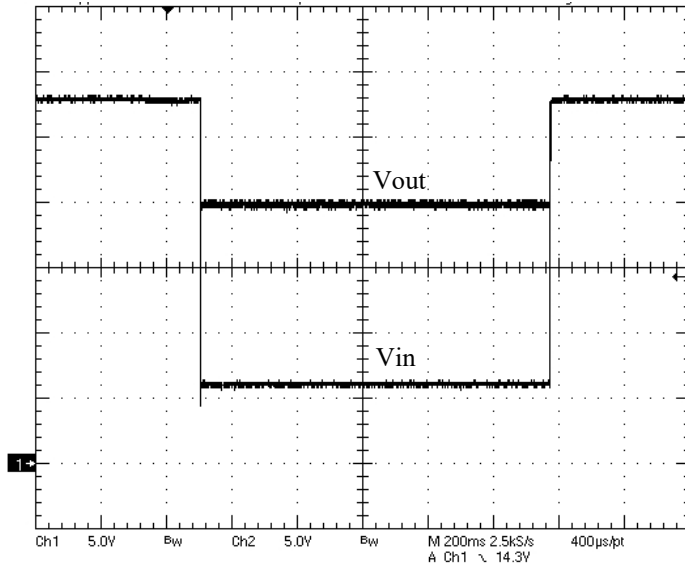


**Figure 7** – Output Power Rating vs Input Voltage

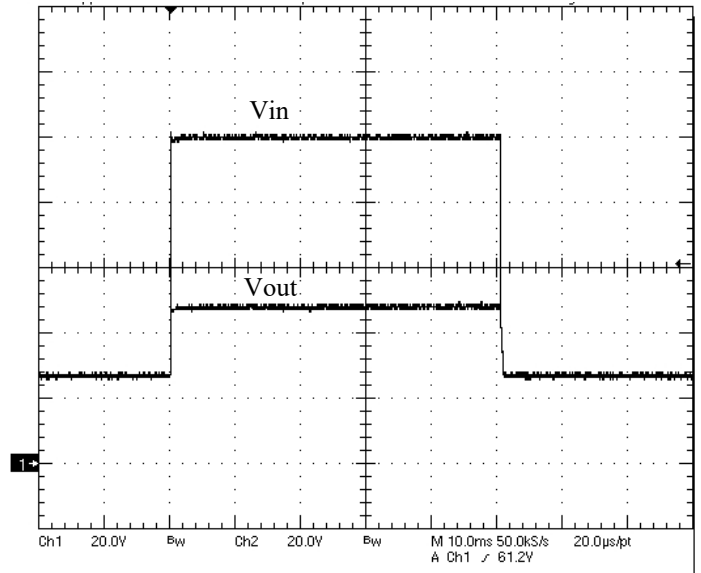


**Figure 8** – Full Load Efficiency vs Input Voltage

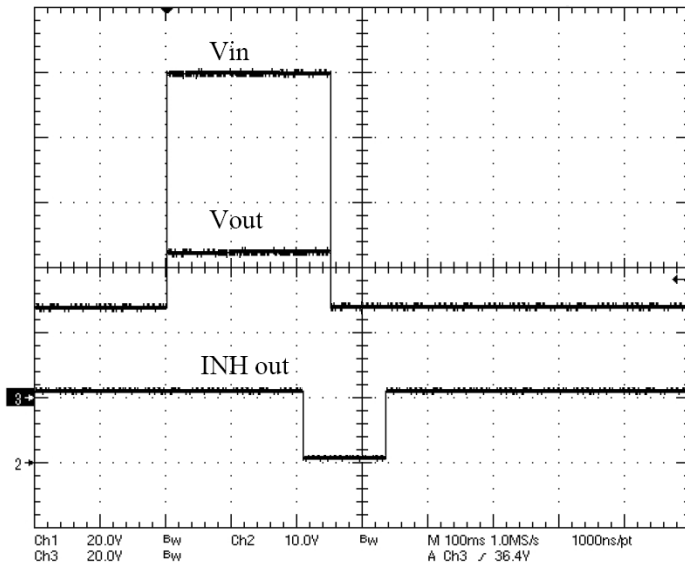
## PERFORMANCE CURVES



**Figure 9 – Vin, Vout during 6V, 1 sec Transient**



**Figure 10 – Vin, Vout during 100V, 50ms Transient**



**Figure 11 – Inhibit Out during 100V Transient**

## PERFORMANCE CURVES

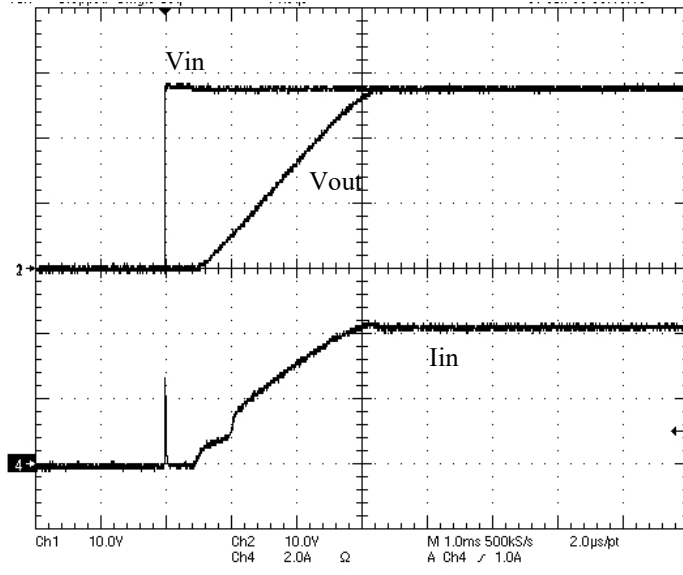


Figure 12 – Vout, Iin (inrush current) during turn-on at 28V

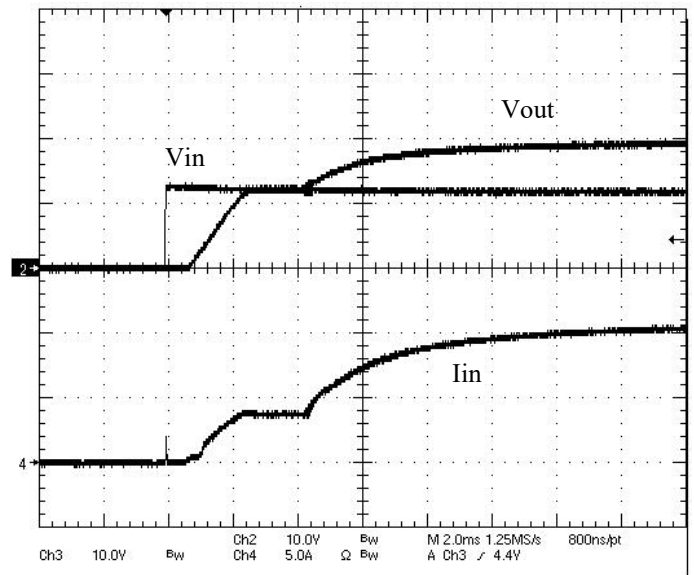


Figure 13 – Vout, Iin (inrush current) during turn-on at 12V

## EMI PERFORMANCE CURVES

( $T_{CASE} = 25^{\circ}C$ ,  $V_{IN} = +12V \pm 5\%$ , Full Load, Unless Otherwise Specified)

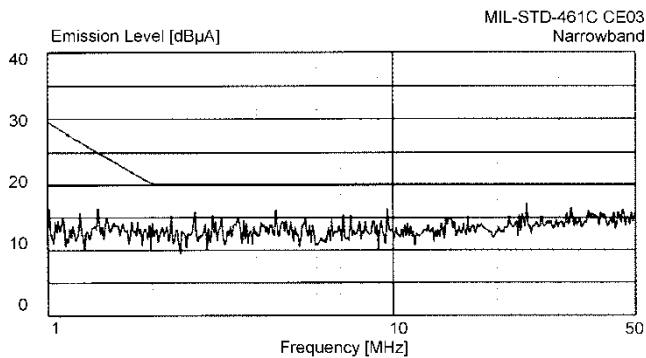
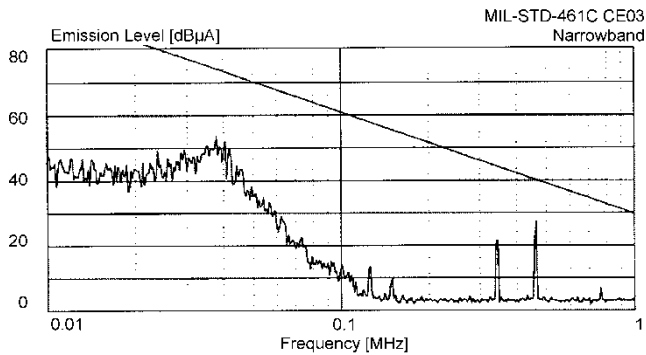


Figure 14 – VPTPCM with VPTF20-28

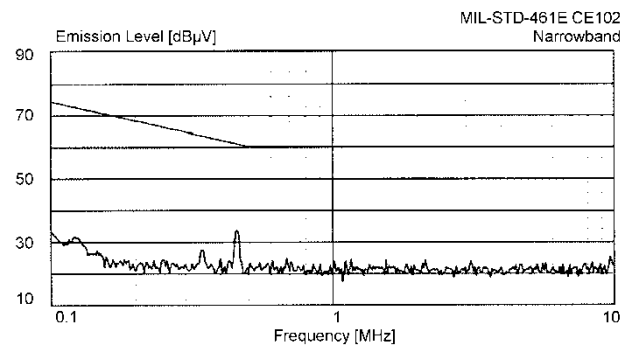
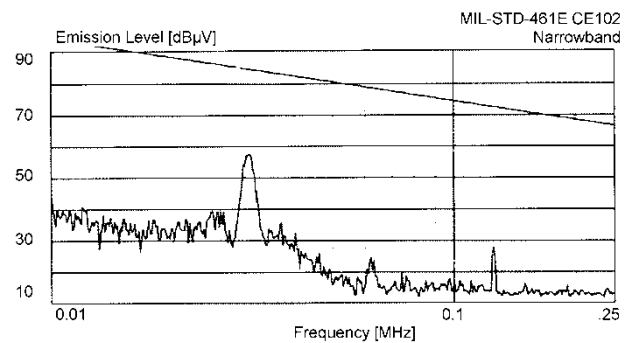
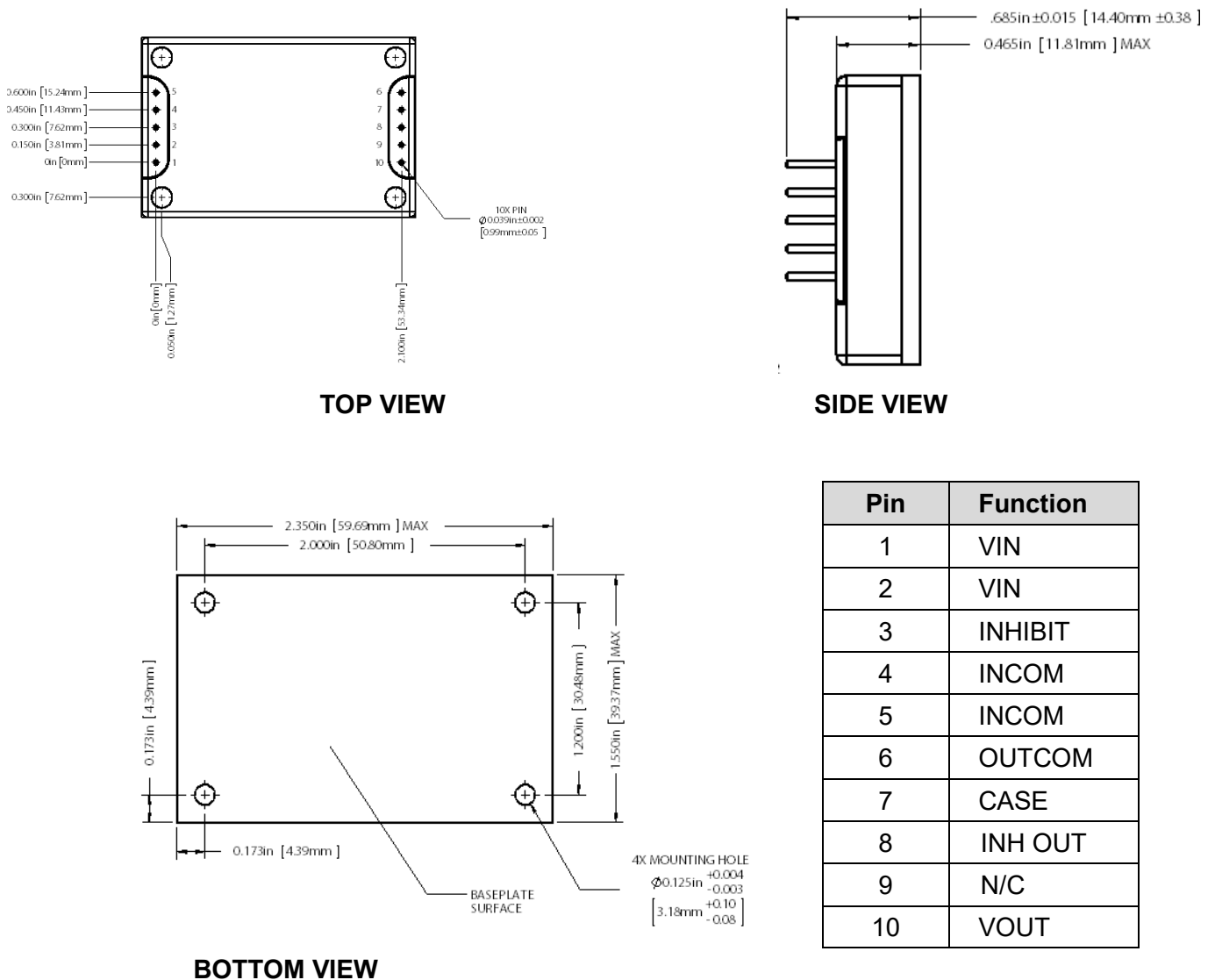


Figure 15 – VPTPCM with VPTF20-28

## STANDARD METAL PACKAGE

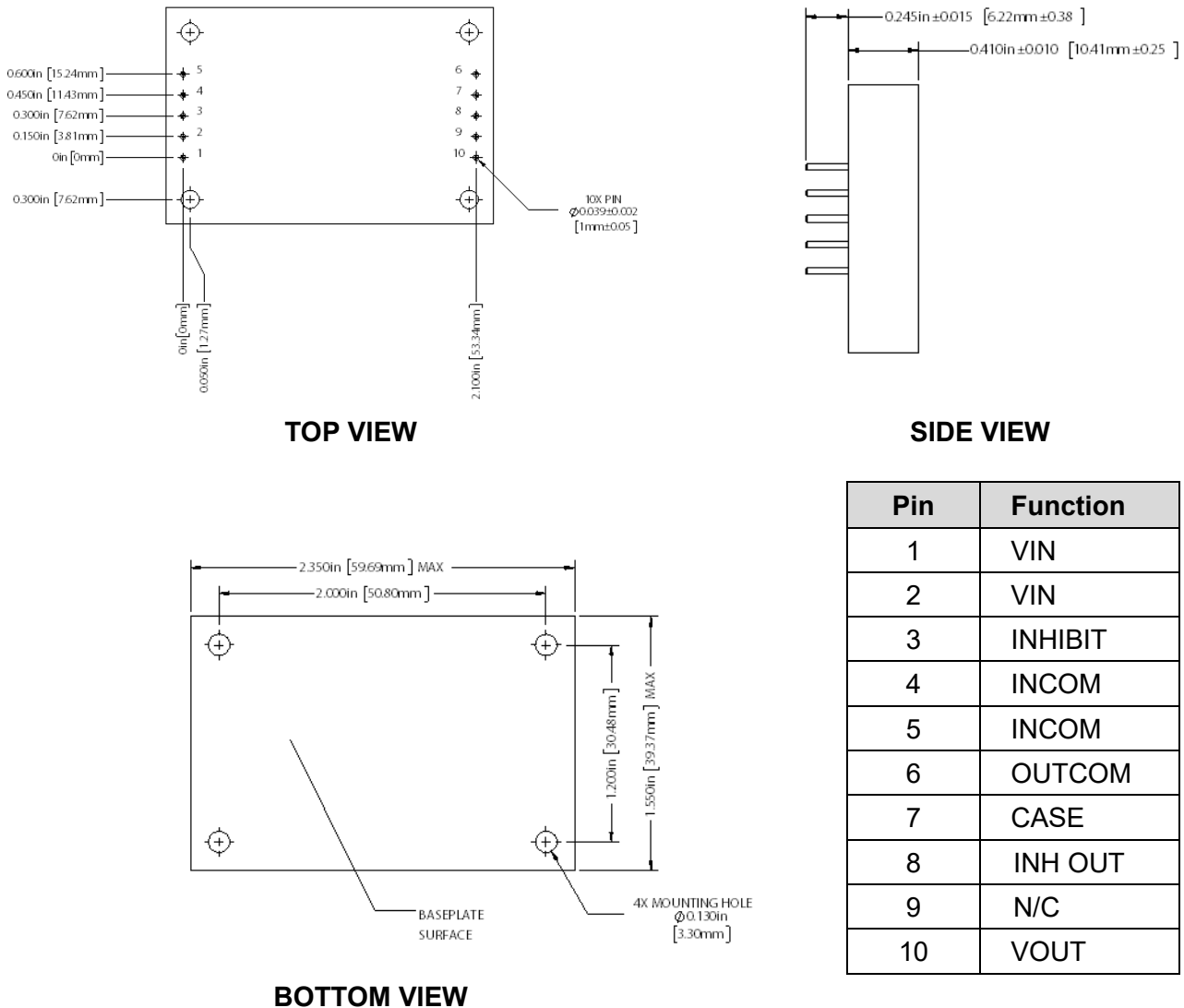


**Figure 16 – Package and Pinout**  
(Dimensional Limits are  $\pm 0.005$ " Unless Otherwise Stated)

### Package Notes

1. Case temperature is measured on the center of the baseplate surface.
2. Materials: Baseplate – aluminum, conductive conversion coating.  
Cover – nickel plated.  
Pins - copper, gold over nickel plating.
3. Mounting holes are not threaded. Recommended fastener is 4-40.
4. This Package is not hermetic. VPT offers a wide range of hermetic products. Please contact VPT for details if hermetic products are required.

## OPTIONAL EPOXY ENCAPSULATED PACKAGE



**Figure 17 – Package and Pinout**  
(Dimensional Limits are ±0.005" Unless Otherwise Stated)

### Package Notes

1. Case temperature is measured on the center of the baseplate surface.
2. Materials: Body - epoxy with integral metalized EMI shield.  
Pins - copper, gold over nickel plating.
3. Mounting holes are not threaded. Recommended fastener is 4-40.
4. This package is highly resistant to chemical, solvent and salt environments and is fully compatible with high volume manufacturing processes including wave solder, cleaning solvents, high pressure sprays and aqueous wash processes.



**PACKAGE PIN DESCRIPTION**

Pin	Function	Description
1	VIN	Positive Input Voltage Connection
2	VIN	Positive Input Voltage Connection
3	INHIBIT	This is an open collector input. Logic Low = Disabled Output. Connect the inhibit pin to input common to disable the output. Unconnected, open collector or open drain = Enabled Output.
4	INCOM	Return Connection
5	INCOM	Return Connection
6	OUTCOM	Return Connection
7	CASE	Case Connection
8	INH OUT	This is an open collector output. It will activate low during a positive input voltage transient. It can be used as a status flag or connected to the Inhibit input of the downstream DC-DC converter to turn the converter off during a transient, when uninterrupted operation is not required. This connection is usually not required. This pin should be left open if not used.
9	N/C	No Connection
10	VOUT	Positive Output Voltage Connection

**100% ENVIRONMENTAL SCREENING**

Screening	Condition
Internal Visual	IPC-A-610, Class 3
Stabilization Bake	MIL-STD-883, Method 1008, Condition B, 125°C, 24 hours
Temperature Cycling	MIL-STD-883, Method 1010, Condition B, -55°C to +125°C, 10 Cycles
Burn-In	96 hours at +100°C
Final Electrical	100% at 25°C
External Visual	Internal Procedure

## ORDERING INFORMATION

VPTPCM-	12	W
1	2	3

(1) Product Series	(2) Nominal Input Voltage		(3) Package Option	
VPTPCM-	12	12 – 28 Volts	None W	Standard Metal Epoxy Encapsulated

## CONTACT INFORMATION

To request a quotation or place orders please contact your sales representative or the VPT Inc. Sales Department at:

**Phone:** (425) 353-3010  
**Fax:** (425) 353-4030  
**E-mail:** [vptsales@vptpower.com](mailto:vptsales@vptpower.com)

All information contained in this datasheet is believed to be accurate, however, no responsibility is assumed for possible errors or omissions. The products or specifications contained herein are subject to change without notice. VPT, its logo and tagline are registered trademarks in the U.S. Patent and Trademark Office.