



VSCF3-28

HIGH RELIABILITY COTS EMI FILTER



VSCF3-28- Exact marking may differ from that shown

Models Available

3A output
-55°C to 100°C operation

1.0 DESCRIPTION

The VSCF3-28 is a commercial off the shelf EMI filter designed for the 'New Space' market. The VSCF3-28 EMI filter is designed to filter the conducted emissions of multiple VSC series DC-DC converters up to its current rating, providing compliance to MIL-STD-461 C-G for conducted emissions. Testing is to JESD22, MIL-STD-810, and MIL-STD-883.

The VSCF3-28 is intended for smaller satellites in low earth orbits (LEO), and NASA Class D missions where the balance of cost and guaranteed performance is critical. The VSCF3-28 is well suited for space applications as it is a fully passive design which is immune to radiation effects. Our proprietary packaging creates a dual side heatsinking option with very low outgassing.

1.1 FEATURES

- Up to 3.0 Amp maximum current
- Up to 75 W output power
- Wide input voltage range: 0 to 50 Volts per MIL-STD-704 and MIL-STD-1275
- High input transient voltage: 80 Volts for 1 sec per MIL-STD-704A
- 55 dB minimum attenuation at 500 kHz
- Wide temperature range, -55 °C to 100 °C
- Internally conformal coated

1.2 MANUFACTURING AND COMPLIANCE

- Manufactured in an ISO9001, J-STD-001, and IPC-A-610 certified facility
- MIL-STD-1275, MIL-STD-704
- Meets MIL-STD-461 C-G conducted emissions requirements when used with a VSC Series DC-DC converter
- Meets conducted susceptibility requirements of MIL-STD-461C, CS01 and CS02, and MIL-STD-461 C-G when used with a VSC Series DC-DC converter

1.3 PACKAGING

- Low-profile: 1.585" x 1.175" x 0.360"
- Max weight: 30 g
- Outgassing less than 1.5% TML and 0.12% CVCM

1.4 ACCESSORIES

- Thermal Pads TP-009 or TP2-009

2.0 DIAGRAMS

2.1 BLOCK DIAGRAM

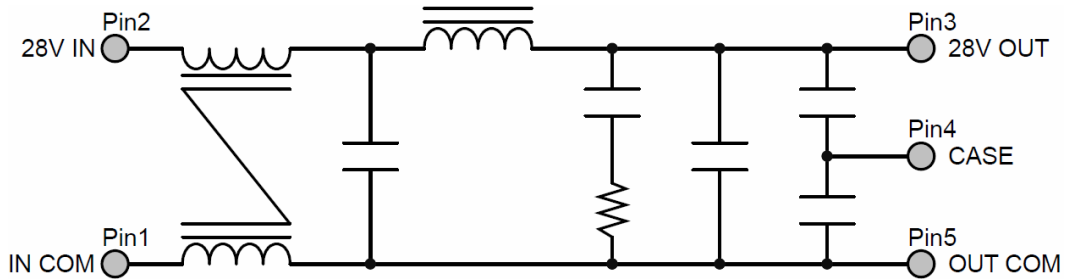

2.2 CONNECTION DIAGRAM

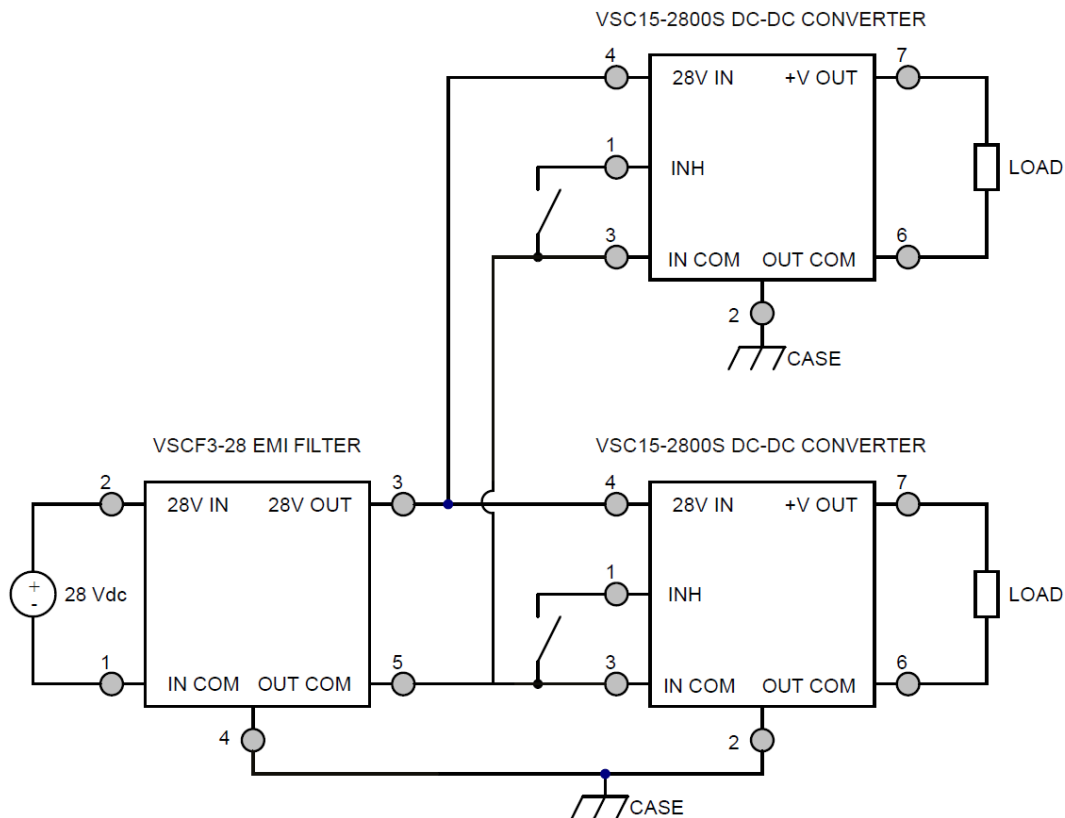

3.0 SPECIFICATIONS

3.1 ABSOLUTE MAXIMUM RATINGS

Absolute Maximum Ratings			
Input Voltage (Continuous):	50 V	Storage Temperature:	-55 °C to +125 °C
Input Voltage (Transient, 1 second):	80 V	Lead Solder Temperature (10 seconds):	300 °C

3.2 PERFORMANCE SPECIFICATIONS

Tcase = -55 °C to +100 °C, Vin = +28 V ± 5%, Full Load, Unless Otherwise Specified

Parameter	Conditions	VSCF3-28			Units
		Min	Typ	Max	
INPUT					
Voltage	Continuous	0	28	50	V
	Transient, 1 sec ²	-	-	80	V
OUTPUT STATIC					
Voltage		$V_{OUT} = V_{IN} - (I_{IN} \times R_{DC})$			V
Current ¹		0	-	3	A
Power ¹		0	-	75	W
GENERAL					
DC Resistance		-	-	250	mΩ
Power Dissipation		-	-	2.3	W
Noise Rejection		55	-	-	dB
Capacitance		10	-	30	nF
Isolation	500 V DC, Tcase = 25 °C	100	-	-	MΩ
Weight		-	-	30	g
MTBF (MIL-HDBK-217F)	SF @ Tcase = 55 °C	-	172	-	MHr

1. Derate linearly to 0 at 110°C.

2. Verified by initial electrical design verification. Post design verification, parameter shall be guaranteed to the limits specified.

4.0 PERFORMANCE CURVES

4.1.1 Two VSC15-2800S without VSCF3-28 EMI Filter

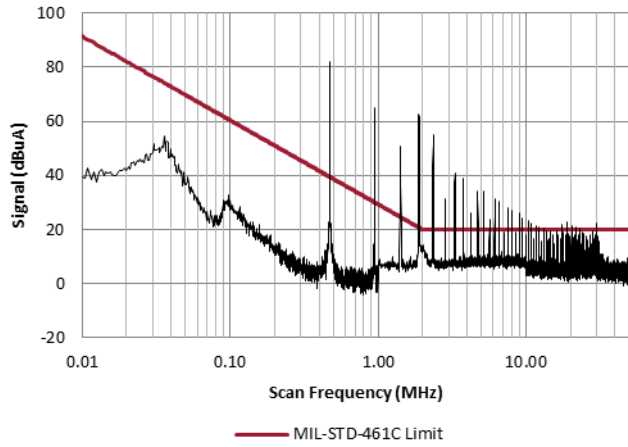

4.1.2 Two VSC15-2800S with VSCF3-28 EMI Filter

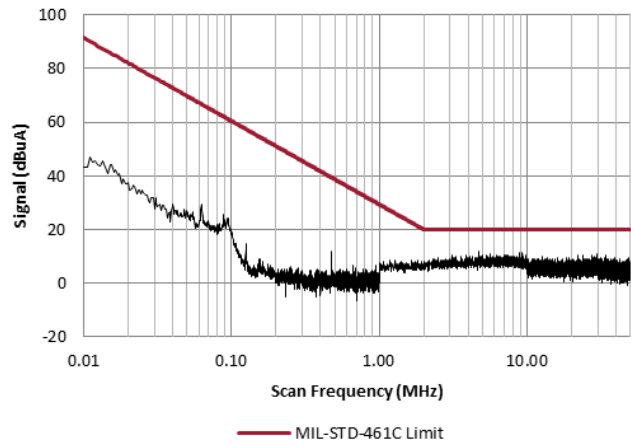

4.1.3 Two VSC15-2800S without VSCF3-28 EMI Filter

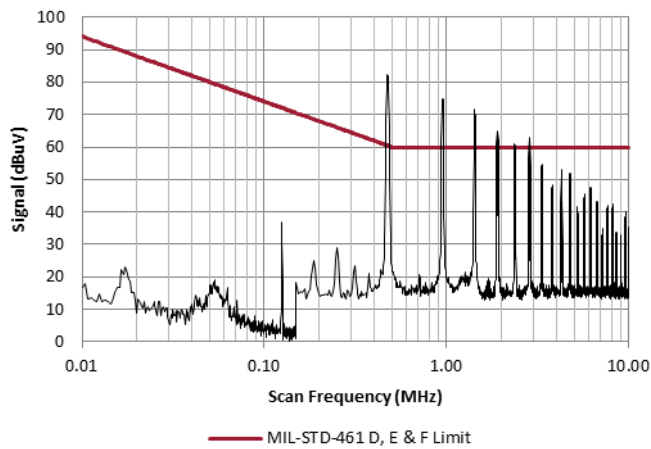

4.1.4 Two VSC15-2800S with VSCF3-28 EMI Filter

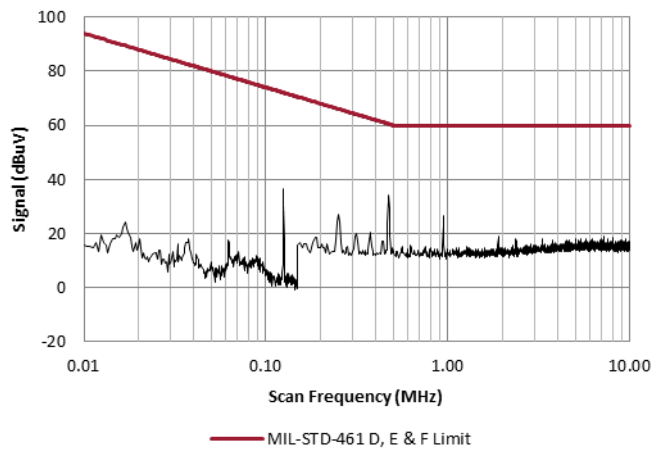

5.0 MECHANICAL OUTLINES AND PINOUT

Standard Package Option:

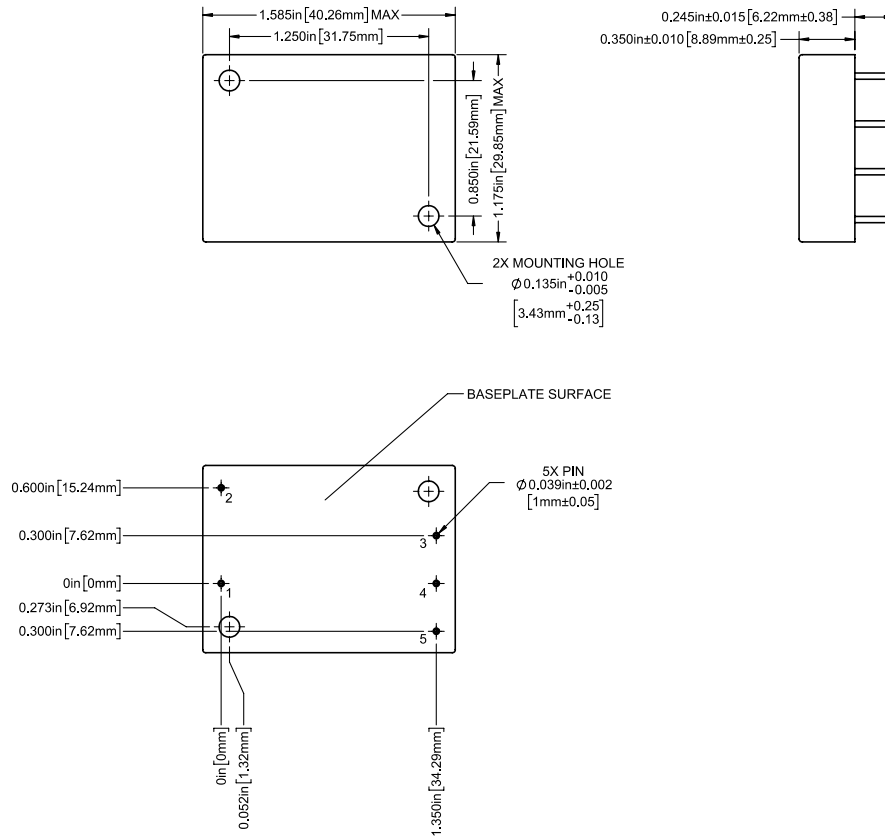

1. Tolerances are $\pm 0.005''$ unless otherwise stated.
2. Case temperature is measured on the center of the baseplate surface.
3. Materials: Body (Epoxy); Pins (Tellurim Copper, alloy 145, gold over nickel plating).
4. Mounting holes are not threaded. Recommended fastener is 4-40.

Pin	Function	Pin	Function
1	INCOM	4	CASE
2	28VIN	5	OUT COM
3	28VOUT		

6.0 THERMAL CONSIDERATIONS

The VSCF3-28 is rated for full power operation at 100 °C. Operation above 100 °C is allowed at reduced power. Specifically, the output power should be derated linearly from full power at 100 °C to half power at 105 °C and to zero power at 110 °C. The operating temperature of the filter is specified on the baseplate or the top plate of the filter. The filter is designed to be conduction-cooled, with the baseplate or the top plate mounted to a heat sink, chassis, PCB or other thermal surface.

7.0 COMPLIANCE

When used with VSC series converters

Specification	Compliance
MIL-STD-416 C-G	CE03
	CE102
	CS101
MIL-STD-704 A-F	Input Voltage
	Distortion spectrum
	Voltage spikes ¹
MIL-STD-1275 A-D	Input voltage, including starting disturbances
	Ripple ²
	Voltage spikes ³
DO-160 E-G, Section 16	Steady state voltage
	Ripple voltage
	Abnormal surge voltage
DO-160 E-G, Section 18	Categories B, R, K and Z ⁴
DO-160 E-G, Section 21	Conducted RF emissions

1. Source impedance is 50 Ohms
2. Injected current limited to 1 Arms per SAEJ1113-2
3. Energy limited to 15 mJ or less
4. Baseplate temperature limited to DO-160 E-G, Table 4-1, Operating High Temp

8.0 ENVIRONMENTAL SCREENING

Test	/ES+
Internal Visual	IPC-A-610, Class 3
Temperature Cycling	MIL-STD-883, Method 1010, Condition B, -55 °C to +125 °C, 10 Cycles
Burn In	96 hours at +100 °C
Final Electrical ¹	-55 °C, 25 °C, 100 °C
External Visual	Internal Procedure

1. 100% R&R testing with all test data included in product shipment

9.0 ORDERING INFORMATION

VSCF3-	28	/ES+
1	2	3

(1) Product Series	(2) Nominal Input Voltage	(3) Screening Code
VSCF3-	28 28 Volts	/ES+

Please contact your sales representative or the VPT Inc. Sales Department for more information concerning additional environmental screening and testing, different input voltage, output voltage, power requirements, and source inspection.

10.0 CONTACT INFORMATION

To request a quotation or place orders please contact your sales representative or the VPT, Inc. Sales Department at:

Phone: (425) 353-3010
Fax: (425) 353-4030
E-mail: vptsales@vptpower.com

All information contained in this datasheet is believed to be accurate, however, no responsibility is assumed for possible errors or omissions. The products or specifications contained herein are subject to change without notice.

11.0 ADDITIONAL INFORMATION

Visit the VPT website for additional technical resources, including:

[Product Catalogs](#)



[Application Notes and White Papers](#)

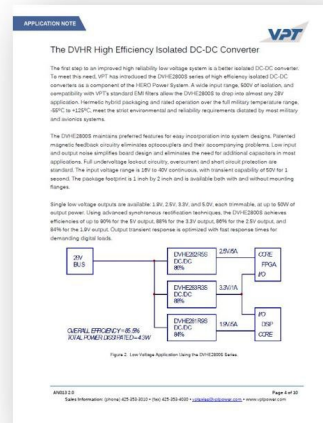

[Technical Video Labs](#)



[Additional Products For Avionics/Military, Hi-Rel COTS, and Space Applications](#)

