



VPTF10-28 SERIES

HIGH RELIABILITY COTS DC-DC CONVERTERS

Models Available
 10 A output
 -55 °C to 100 °C Operation

1.0 DESCRIPTION

The VPTF10 series of COTS EMI filters is a cost effective solution for many demanding high reliability applications. A wide input voltage range accommodates nominal 28V inputs including avionics, mobile, ground systems, and other applications. The VPTF10 EMI filter is designed to filter the conducted emissions of multiple VPT series DC-DC converters up to its current rating, providing compliance to MIL-STD-461C/D/E for conducted emissions. A proven design heritage, no optoisolators and a rugged all metal or optional epoxy encapsulated package ensure long term reliability.

The VPTF10 series is intended for harsh environments including severe vibration, shock and temperature cycling. Testing is to JESD22, MIL-STD-810, and MIL-STD-883.

These converters are designed and manufactured in a facility certified to ISO9001, J-STD-001 and IPC-A-610.

This product may incorporate one or more of the following U.S. patents:

- 5,784,266
- 5,790,389
- 5,963,438
- 5,999,433
- 6,005,780
- 6,084,792
- 6,118,673



1.1 FEATURES

- High reliability at low cost
- Up to 10.0 Amp maximum current
- Up to 200 W output power
- Wide input voltage range: 0 to 50 Volts per MIL-STD-704 and MIL-STD-1275
- High input transient voltage: 80 Volts for 1 sec per MIL-STD-704A
- 45 dB minimum attenuation at 500 kHz
- Wide temperature range, -55 °C to 100 °C
- Internally conformal coated
- Standard six sided non-hermetic rugged metal package
- Optional six sided rugged epoxy encapsulated V-SHIELD® Package with integral metalized EMI shield that is fully compatible with aqueous cleaning processes

1.2 COMPLIANCE

- MIL-STD-1275, MIL-STD-704
- Meets MIL-STD-461C-G conducted omissions requirements when used with a VPT Series DC-DC converter
- Meets conducted susceptibility requirements of MIL-STD-461C, CS01 and CS02, and MIL-STD-461C-G when used with a VPT Series DC-DC converter
- Meets EN55022/EN55032 Class A and B when used with an appropriate VPT DC-DC Converter

1.3 PACKAGING

- Low-profile: 1.885" x 1.325" x 0.400"
- Optional Rugged Epoxy Encapsulated V-SHIELD® Package
- Max weight: 40 g

1.4 SIMILAR PRODUCTS AND ACCESSORIES

- [DVMD28](#) 7 A EMI filter for military/avionics applications
- [VXRF10-28](#) 10 A EMI filter for military/commercial applications
- [VHRF10](#) 10 A EMI filter for military/commercial applications
- [EMI filters, Thermal Pads, Front-End Modules and Accessories](#)

2.0 DESCRIPTION

2.1 BLOCK DIAGRAM

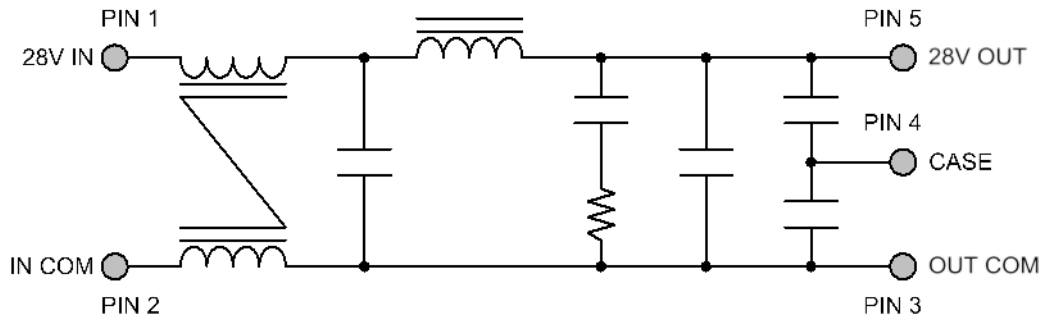

2.2 CONNECTION DIAGRAM

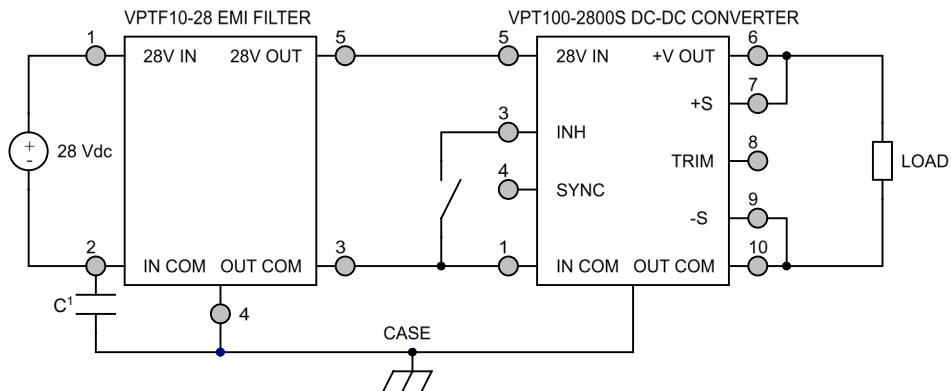

1. 0.47 μ F / 500V minimum required for EN55022 and EN55032 only

2.2 CONNECTION DIAGRAM (CONTINUED)

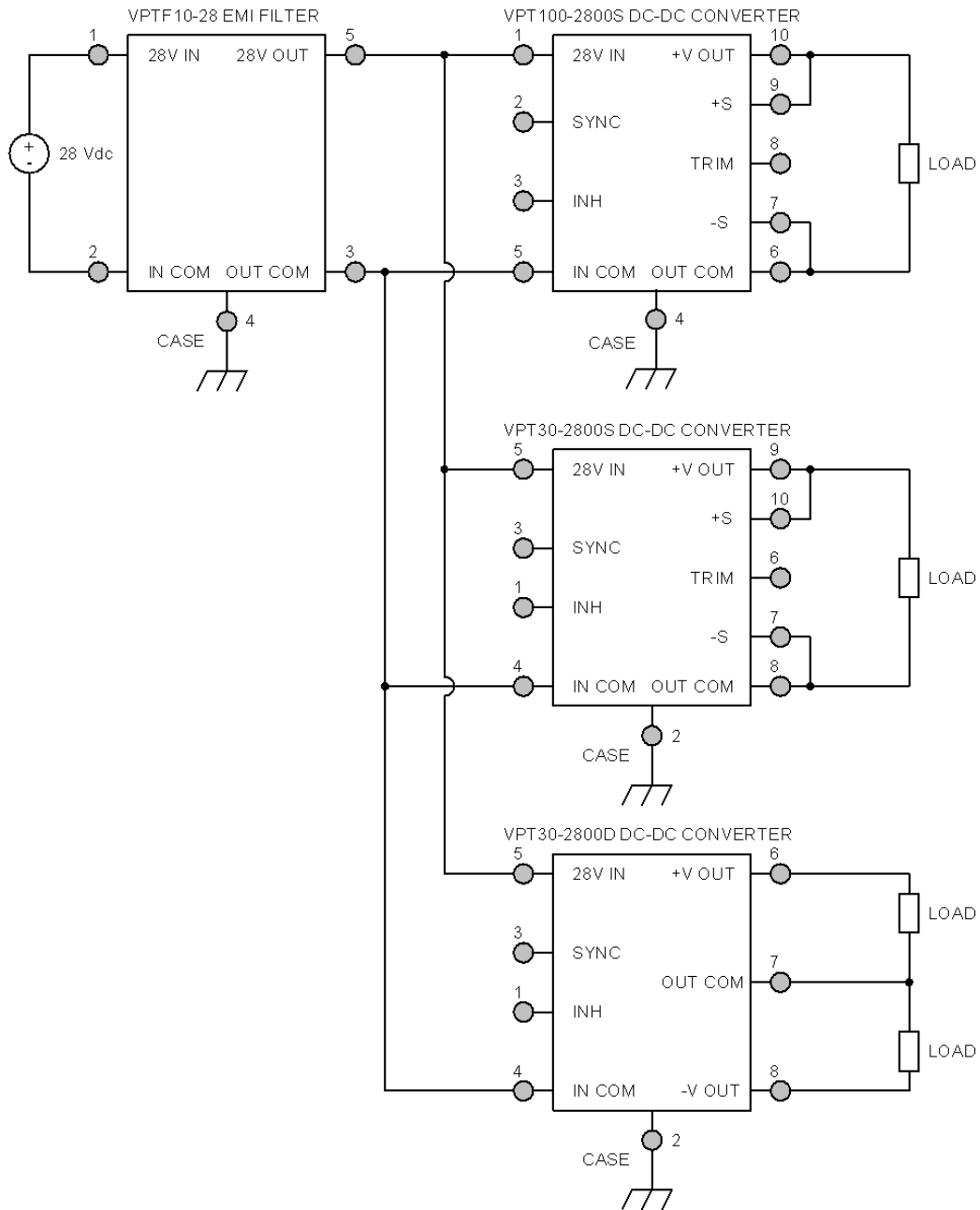

3.0 SPECIFICATIONS

3.1 ABSOLUTE MAXIMUM RATINGS

Absolute Maximum Ratings

Input Voltage (Continuous)	50 V	Storage Temperature	-55 °C to 125 °C
Input Voltage (Transient, 1 second)	80 V	Lead Solder Temperature (10 seconds)	300 °C

3.2 PERFORMANCE SPECIFICATIONS

T_{case} = -55 °C to 100 °C, V_{in} = +28 V ± 5%, Full Load, Unless Otherwise Specified

VPTF10-28					
Parameter	Conditions	Min	Typ	Max	Units
INPUT					
Voltage	Continuous	0	28	50	V
	Transient, 1 sec ²	-	-	80	V
OUTPUT STATIC					
Voltage		$V_{OUT} = V_{IN} - (I_{IN} \times R_{DC})$			V
Current ¹		0	-	10	A
Power ¹		0	-	200	W
GENERAL					
DC Resistance		-	45	80	mΩ
Power Dissipation ²		-	-	8	W
Noise Rejection	f = 500 kHz	45	-	-	dB
Capacitance	Any Pin to Case	70	-	130	nF
Isolation	Any Pin to Case, 500 VDC	100	-	-	MΩ
Weight		-	-	40	g
MTBF (MIL-HDBK-217F)	GM @ TC = 55 °C	-	802	-	kHr

1. Derate linearly to 0 at 110 °C.
2. Verified by initial electrical design verification. Post design verification, parameter shall be guaranteed to the limits specified.



4.0 PERFORMANCE CURVES

Tcase = 25 °C, Vin = +28 V ± 5%, Full Load, Unless Otherwise Specified

4.1.1 One VPT100-2800S without VPTF10-28 EMI Filter

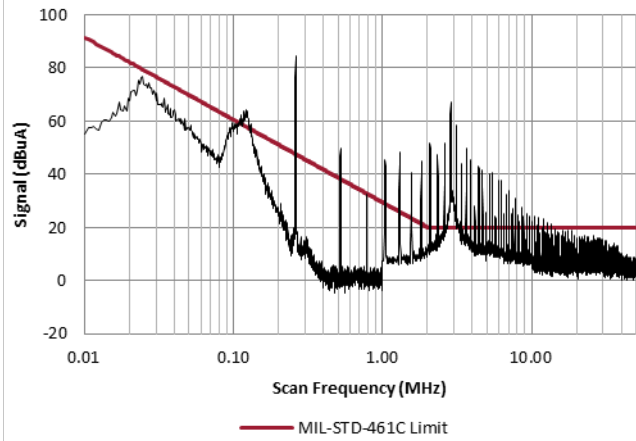

4.1.2 One VPT100-2800S with VPTF10-28 EMI Filter

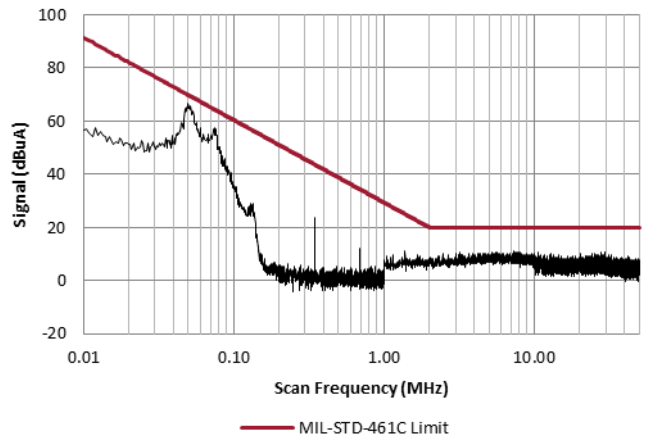

4.1.3 One VPT100-2800S without VPTF10-28 EMI Filter

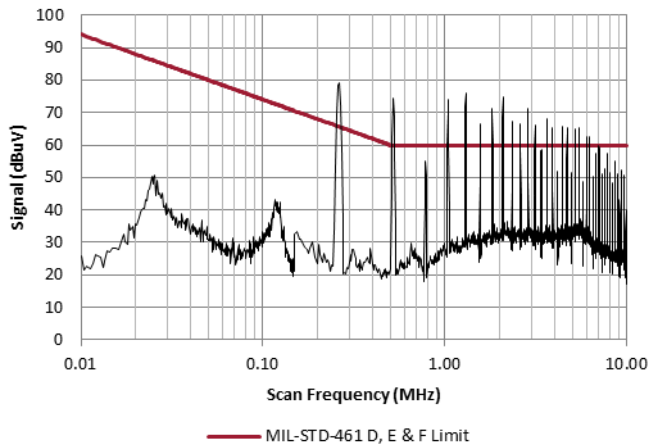

4.1.4 One VPT100-2800S with VPTF10-28 EMI Filter

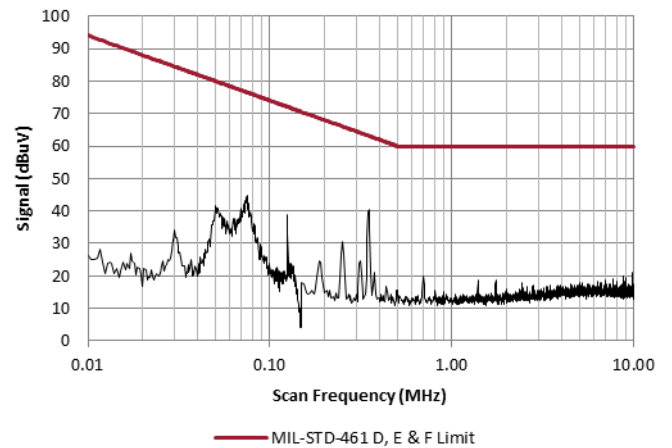

4.0 PERFORMANCE CURVES (CONTINUED)

Tcase = 25 °C, Vin = +28 V ± 5%, Full Load, Unless Otherwise Specified

4.1.5 Three VPT30-2800S without VPTF10-28 EMI Filter

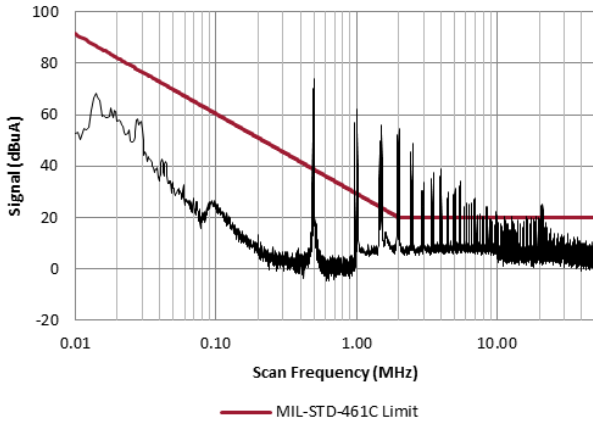

4.1.6 Three VPT30-2800S with VPTF10-28 EMI Filter

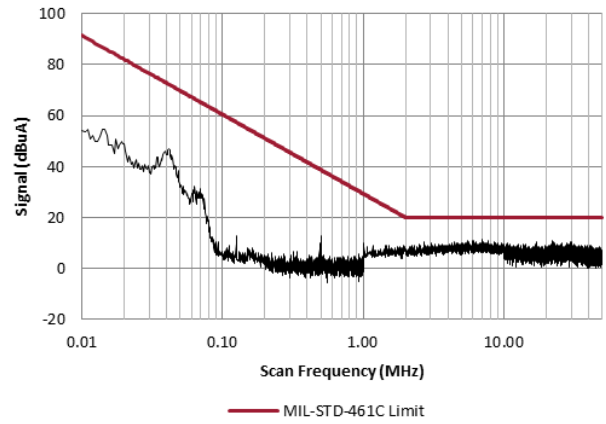

4.1.7 Three VPT30-2800S without VPTF10-28 EMI Filter

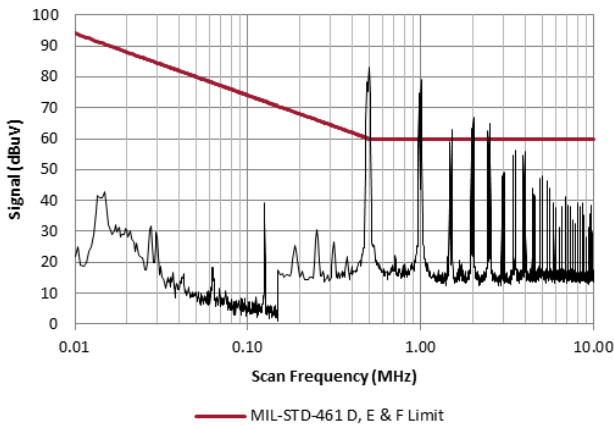

4.1.8 Three VPT30-2800S with VPTF10-28 EMI Filter

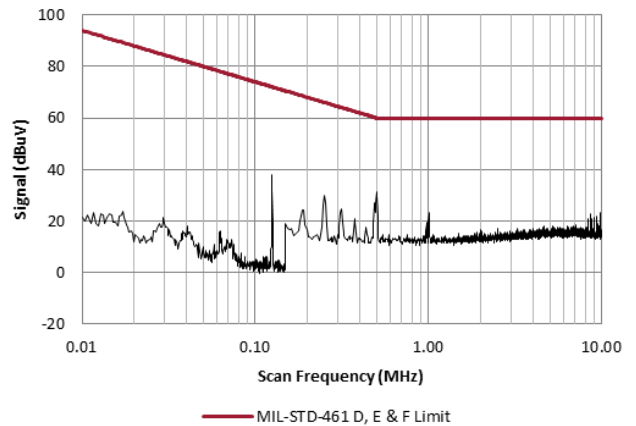

4.1.9 One VPT100-2800S with VPTF10-28 EMI Filter^{1, 2, 3}

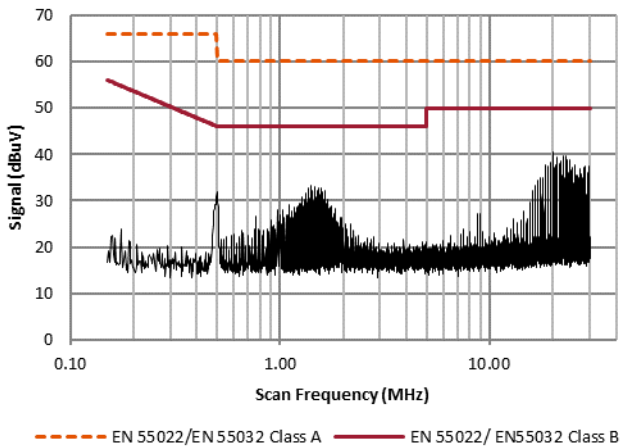

4.1.10 Three VPT30-2800S with VPTF10-28 EMI Filter^{1, 2}

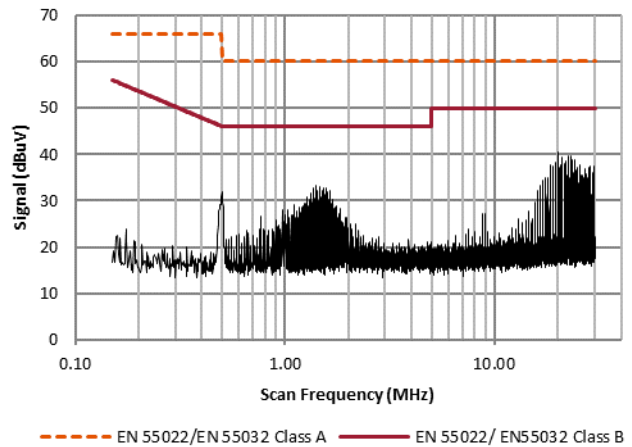

1. Minimum 0.47 uF 500 V capacitor required as shown in Section 2.2
2. Tcase = 25 °C, Vin = +24 V ± 5%, Full Load
3. Limit lines shown are average limit

1. Tcase = 25 °C, Vin = +24 V ± 5%, Full Load
2. Limit lines shown are average limit

5.0 MECHANICAL OUTLINES AND PINOUT

Standard Metal Package:

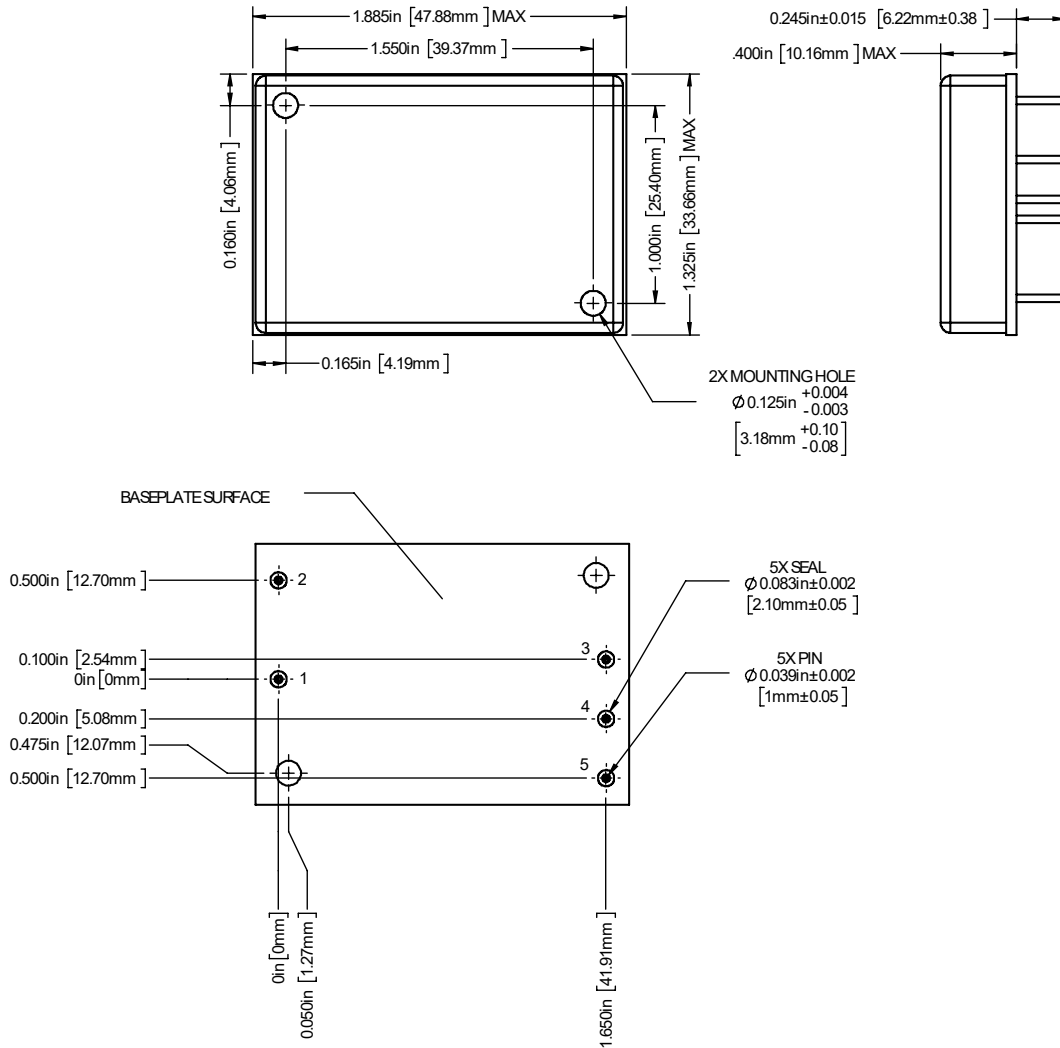

1. Case temperature is measured on the center of the baseplate surface
2. Materials: Baseplate (Aluminum, conductive conversion coating); Cover (Nickel Plated); Pins (Copper, gold over nickel plating)
3. Mounting holes are not threaded. Recommended fastener is 4-40
4. This Package is not hermetic. VPT offers a wide range of hermetic products. Please contact VPT for details if hermetic products are required

Pin	Function	Pin	Function
1	28VIN	4	CASE
2	INCOM	5	28VOUT
3	OUTCOM		

5.0 MECHANICAL OUTLINES AND PINOUT (CONTINUED)

Optional Epoxy Encapsulated Package:

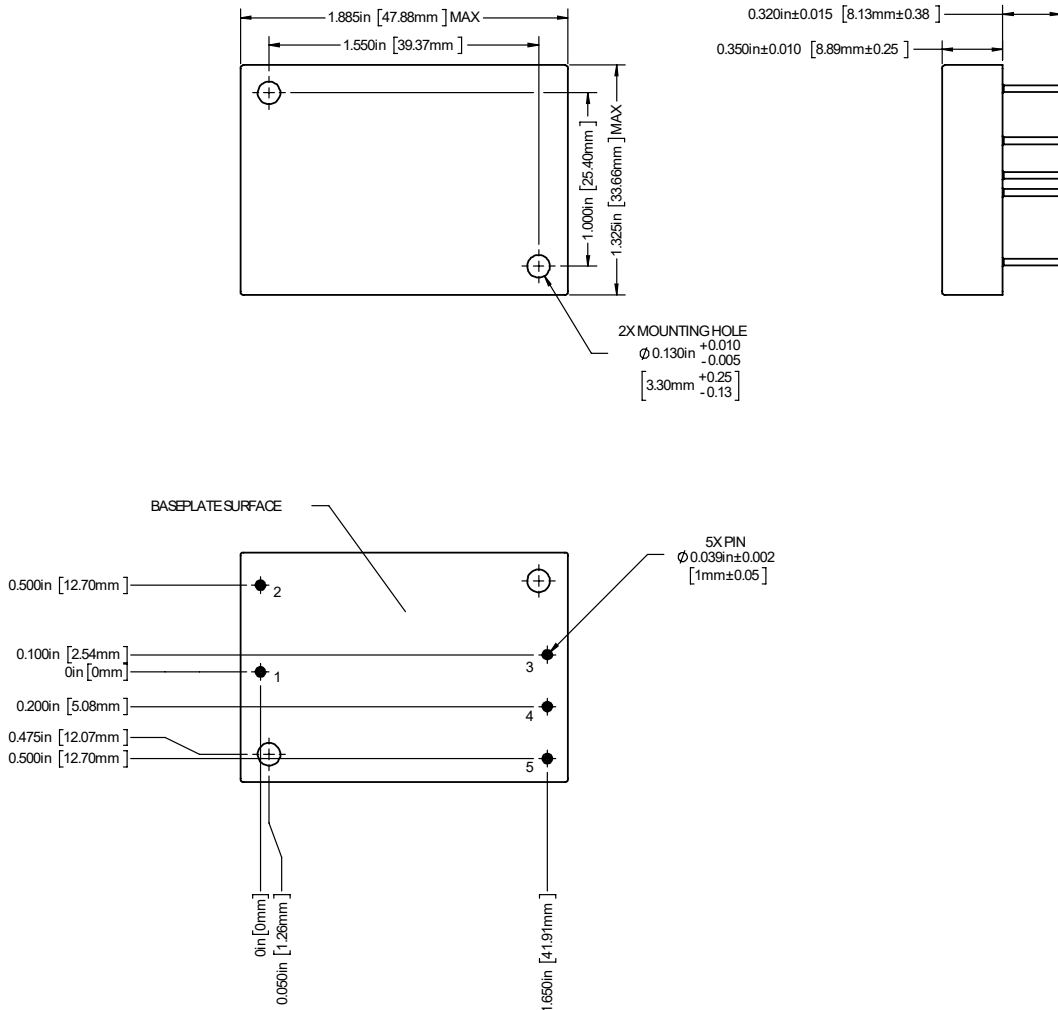

1. Case temperature is measured on the center of the baseplate surface
2. Materials: Body (Epoxy with integral metalized EMI shield); Pins (Copper, gold over nickel plating)
3. Mounting holes are not threaded. Recommended fastener is 4-40
4. This package is highly resistant to chemical, solvent and salt environments and is fully compatible with high volume manufacturing processes including wave solder, cleaning solvents, high pressure sprays and aqueous wash processes

Pin	Function	Pin	Function
1	28VIN	4	CASE
2	INCOM	5	28VOUT
3	OUTCOM		



6.0 PACKAGE PIN DESCRIPTION

Pin	Function	Description
1	28VIN	Positive Input Voltage Connection
2	INCOM	Input Return Connection
3	OUTCOM	Output Return Connection
4	CASE	Case Connection
5	28VOUT	Positive Output Voltage Connection

7.0 ENVIRONMENTAL SCREENING

Screening	Condition
Internal Visual	IPC-A-610, Class 3
Temperature Cycling	MIL-STD-883, Method 1010, Condition B, -55°C to +125°C, 10 Cycles
Burn-In	96 hours at +100°C
Final Electrical	100% at 25 °C
External Visual	Internal Procedure

8.0 ORDERING INFORMATION

VPTF10	28	W
1	2	3

(1) Product Series	(2) Nominal Input Voltage	(3) Output Voltage
-----------------------	------------------------------	-----------------------

VPTF10-	28	28 Volts	None W	Standard Metal Epoxy Encapsulated
---------	----	----------	-----------	--------------------------------------

Please contact your sales representative or the VPT Inc. Sales Department for more information concerning additional environmental screening and testing, different input voltage, output voltage, power requirements, and source inspection.

9.0 CONTACT INFORMATION

To request a quotation or place orders please contact your sales representative or the VPT, Inc. Sales Department at:

Phone: (425) 353-3010
Fax: (425) 353-4030
E-mail: vptsales@vptpower.com

All information contained in this datasheet is believed to be accurate, however, no responsibility is assumed for possible errors or omissions. The products or specifications contained herein are subject to change without notice. VPT, its logo and tagline are registered trademarks in the U.S. Patent and Trademark Office.

10.0 ADDITIONAL INFORMATION

Visit the [VPT website](http://www.vptpower.com) for additional technical resources, including:

[Product Literature](#)



[Application Notes and White Papers](#)

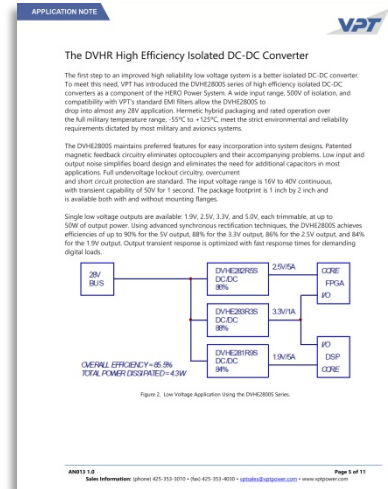

[Technical Video Labs](#)



Additional Products For [Avionics/Military](#), [Hi-Temp](#), [Hi-Rel COTS](#), and [Space Applications](#)

