

DESCRIPTION

The VPTF1 series of COTS EMI filters is a cost effective solution for many demanding high reliability applications. A wide input voltage range accommodates nominal 28V inputs including avionics, mobile, ground systems, and other applications. The VPTF1 EMI filter is designed to filter the conducted emissions of multiple VPT series DC-DC converters up to its current rating, providing compliance to MIL-STD-461C/D/E for conducted emissions. A proven design heritage, no optoisolators and a rugged all metal or optional epoxy encapsulated package ensure long term reliability.

The VPTF1 series is intended for harsh environments including severe vibration, shock and temperature cycling. Testing is to JESD22, MIL-STD-810, and MIL-STD-883.

These converters are designed and manufactured in a facility certified to ISO9001, J-STD-001 and IPC-A-610.

This product may incorporate one or more of the following U.S. patents:

5,784,266
5,790,389
5,963,438
5,999,433
6,005,780
6,084,792
6,118,673

FEATURES

- High Reliability at Low Cost
- Up to 1.0 Amp Maximum Current
- Up to 25W Output Power
- Wide Input Voltage Range: 0 to 50 Volts per MIL-STD-704 and MIL-STD-1275
- High Input Transient Voltage: 80 Volts for 1 sec per MIL-STD-704A
- 55 dB Minimum Attenuation at 500 kHz
- Wide Temperature Range, -55°C to 100°C
- Internally Conformal Coated
- Standard Six Sided Non-Hermetic Rugged Metal Package
- Optional Six Sided Rugged Epoxy Encapsulated Package with Integral Metalized EMI shield that is fully compatible with aqueous cleaning processes
- Meets MIL-STD-461C/D/E Conducted Emissions Requirements When Used With a VPT Series DC-DC Converter
- Meets Conducted Susceptibility Requirements of MIL-STD-461C, CS01 and CS02, and MIL-STD-461D/E when used with a VPT Series DC-DC Converter



Figure 1 – VPTF1-28 EMI Filter
Standard Metal Package

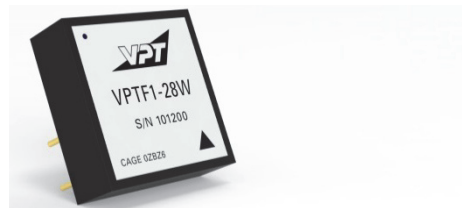

Figure 2 VPTF1-28W EMI Filter
Optional Epoxy Encapsulated Package

(Not to Scale)

SPECIFICATIONS (T_{CASE} = -55°C to +100°C, V_{IN} = +28V ± 5%, Full Load, Unless Otherwise Specified)

ABSOLUTE MAXIMUM RATINGS

Input Voltage (Continuous)	50 V _{DC}	Storage Temperature	-55°C to +125°C
Input Voltage (Transient, 1 second)	80 Volts	Lead Solder Temperature (10 seconds)	300°C
Output Current	1.0 Amps	Weight (Maximum)	21 Grams
Power Dissipation (Full Load, T _{CASE} = +100°C)	0.25 Watt		

Parameter	Conditions	VPTF1-28			Units
		Min	Typ	Max	
STATIC					
INPUT Voltage	Continuous	0	28	50	V
	Transient, 1 sec ²	-	-	80	V
OUTPUT Voltage		$V_{OUT} = V_{IN} - (I_{IN} \times R_{DC})$			V
Current ¹		0	-	1.0	A
Power		0	-	25	W
DC RESISTANCE		-	-	250	mΩ
POWER DISSIPATION ²		-	-	0.25	W
NOISE REJECTION	f = 500 kHz	55	-	-	dB
CAPACITANCE	Any Pin to Case	10	-	30	nF
ISOLATION	Any Pin to Case, 500 VDC	100	-	-	MΩ
MTBF (MIL-HDBK-217F)	GM @ T _c = 55°C	-	1.67	-	MHrs

- Notes: 1. Derate linearly to 0 at 110°C
 2. Verified by qualification testing

BLOCK DIAGRAM

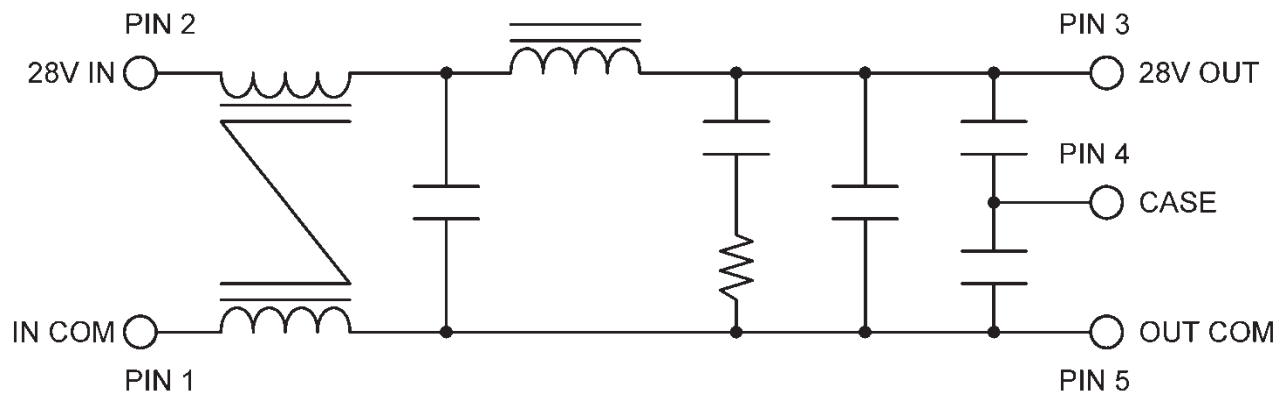

Figure 3

CONNECTION DIAGRAMS

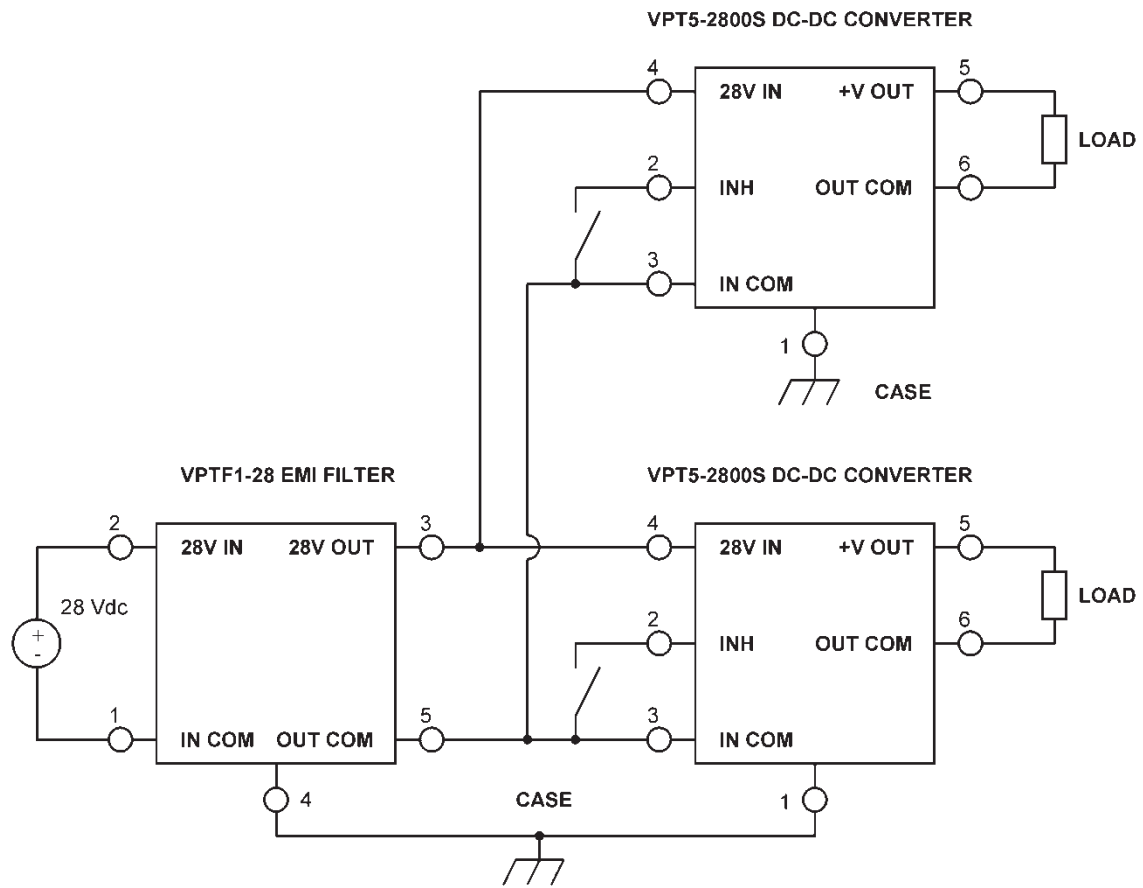

Figure 4
(Shown with multiple VPT Series DC-DC Converters)

EMI PERFORMANCE CURVES

($T_{CASE} = 25^{\circ}C$, $V_{IN} = +28V \pm 5\%$, Full Load, Unless Otherwise Specified)

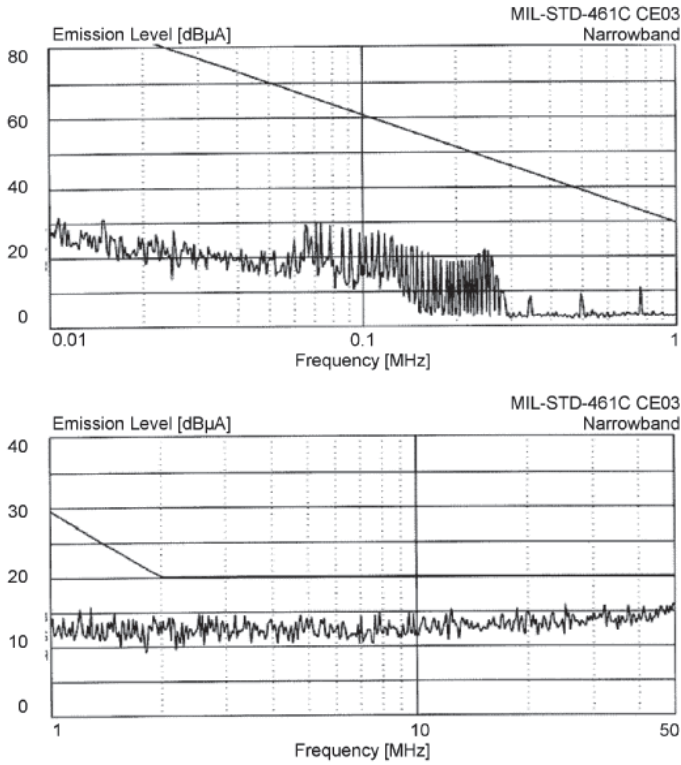

Figure 5 – MIL-STD-461C
Two VPT5-2800S With VPTF1-28 EMI Filter

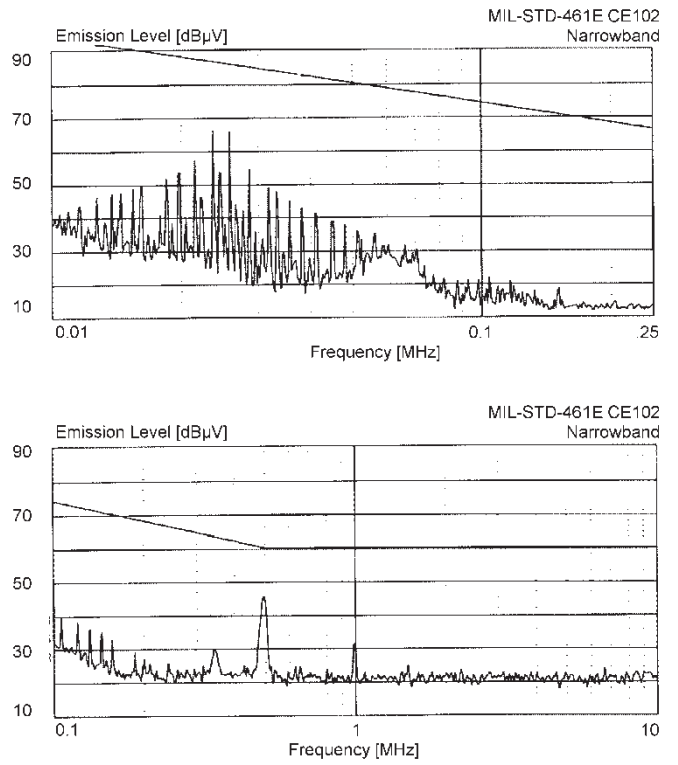

Figure 6 – MIL-STD-461D/E
Two VPT5-2800S With VPTF1-28 EMI Filter

STANDARD METAL PACKAGE

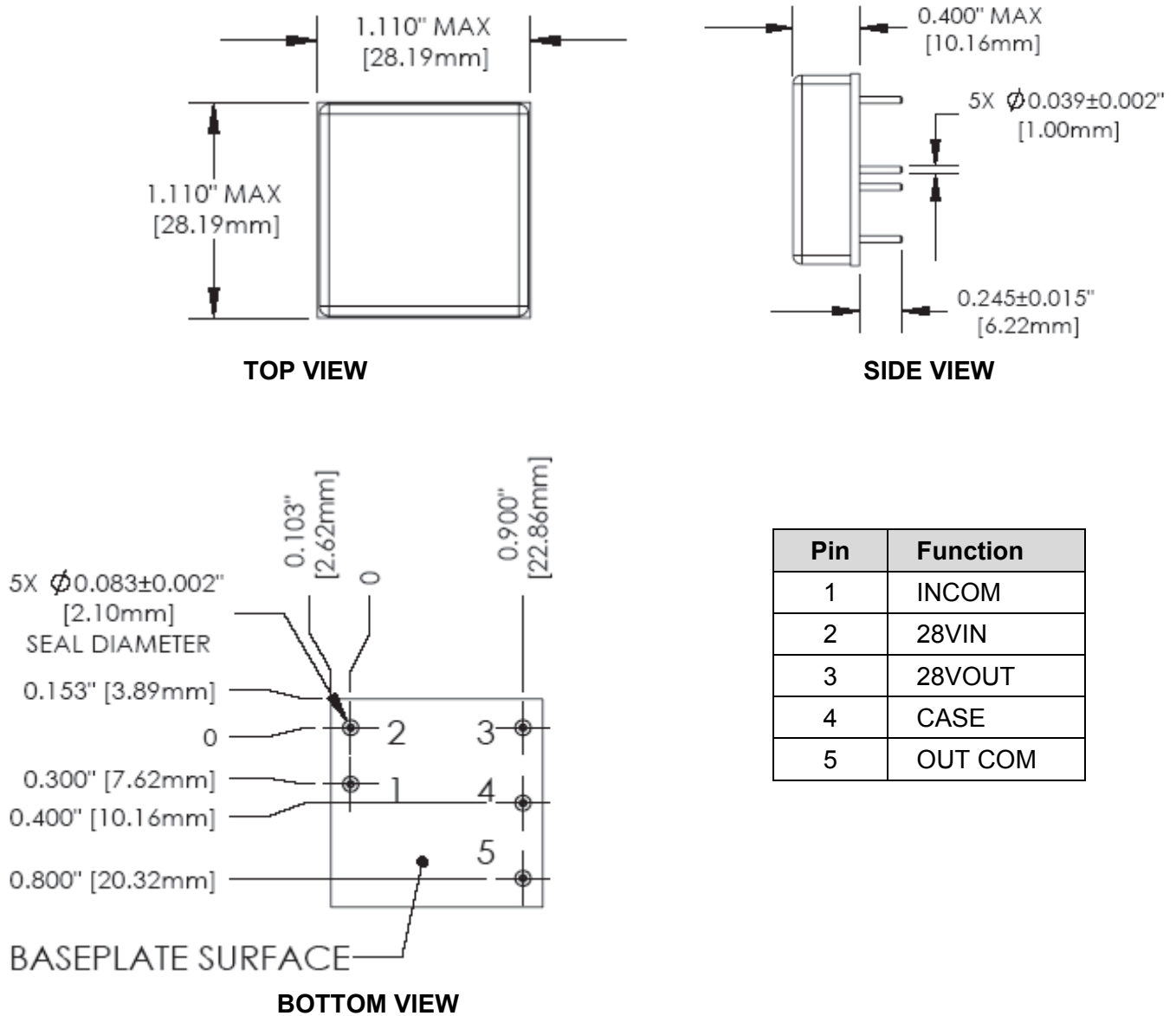

Figure 7 – Package and Pinout
(Dimensional Limits are ± 0.005 " Unless Otherwise Stated)

Package Notes

- Case temperature is measured on the center of the baseplate surface.
- Materials: Baseplate – aluminum, conductive conversion coating.
Cover – nickel plated.
Pins - copper, gold over nickel plating.
- This Package is not hermetic. VPT offers a wide range of hermetic products. Please contact VPT for details if hermetic products are required.

OPTIONAL EPOXY ENCAPSULATED PACKAGE

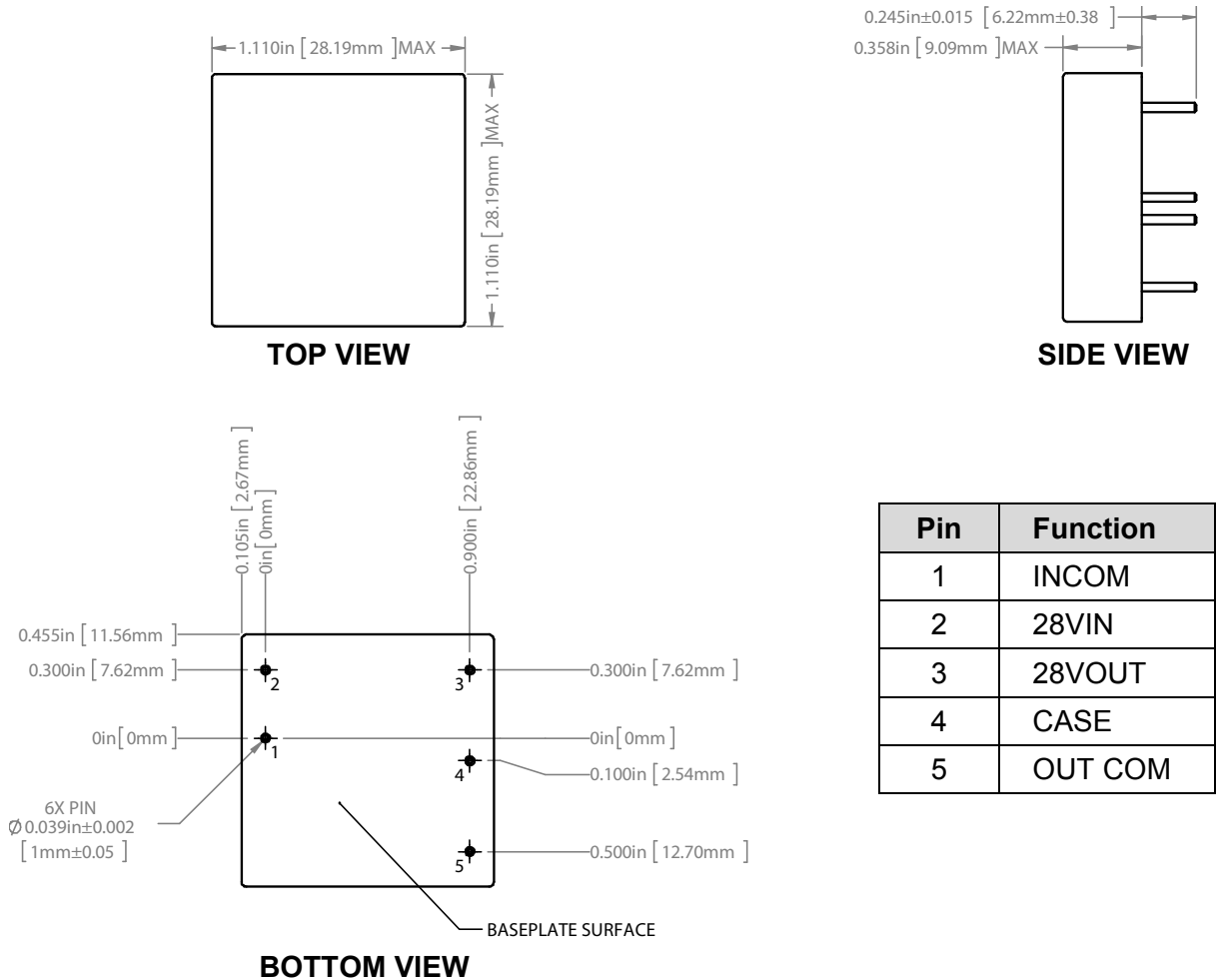

Figure 8 –Package and Pinout
(Dimensional Limits are ±0.005” Unless Otherwise Stated)

Package Notes

1. Case temperature is measured on the center of the baseplate surface.
2. Materials: Body - epoxy with integral metalized EMI shield.
Pins - copper, gold over nickel plating.
3. This package is highly resistant to chemical, solvent and salt environments and is fully compatible with high volume manufacturing processes including wave solder, cleaning solvents, high pressure sprays and aqueous wash processes.

PACKAGE PIN DESCRIPTION

Pin	Function	Description
1	INCOM	Input Return Connection
2	28VIN	Positive Input Voltage Connection
3	28VOUT	Positive Output Voltage Connection
4	CASE	Case Connection
5	OUTCOM	Output Return Connection

100% ENVIRONMENTAL SCREENING

Screening	Condition
Internal Visual	IPC-A-610, Class 3
Stabilization Bake	MIL-STD-883, Method 1008, Condition B, 125°C, 24 hours
Temperature Cycling	MIL-STD-883, Method 1010, Condition B, -55°C to +125°C, 10 Cycles
Burn-In	96 hours at +100°C
Final Electrical	100% at 25°C
External Visual	Internal Procedure

ORDERING INFORMATION

VPTF1-	28	W
1	2	3

(1) Product Series	(2) Nominal Input Voltage		(3) Package Option	
VPTF1-	28	28 Volts	None W	Standard Metal Epoxy Encapsulated

CONTACT INFORMATION

To request a quotation or place orders please contact your sales representative or the VPT Inc. Sales Department at:

Phone: (425) 353-3010
Fax: (425) 353-4030
E-mail: vptsales@vptpower.com

All information contained in this datasheet is believed to be accurate, however, no responsibility is assumed for possible errors or omissions. The products or specifications contained herein are subject to change without notice. VPT, its logo and tagline are registered trademarks in the U.S. Patent and Trademark Office.